

Installation Guide

Mobile Electronics

PVREL



520L0507

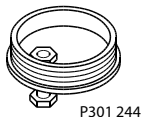

P301 244

 155B342.10	Standard with spring return	155U2601
	Standard with spring return and with neutral switch	155U2605

 155B343.10	Friction hold, by turning the knob	155U2602
	Friction hold, by turning the knob and with neutral switch	155U2606

 155B344.10	Neutral lock and spring return	155U2603
	Neutral lock and spring return with neutral switch	155U2607

 155B345.10	Float position lock and spring return	155U2604
	Float position lock and spring return with neutral switch	155U2608

	Bottom cover	155U2600
--	--------------	----------

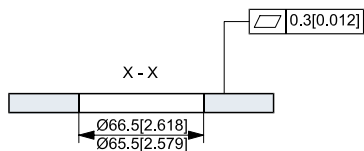
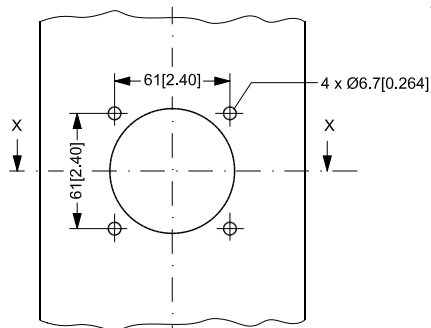

155B402.10

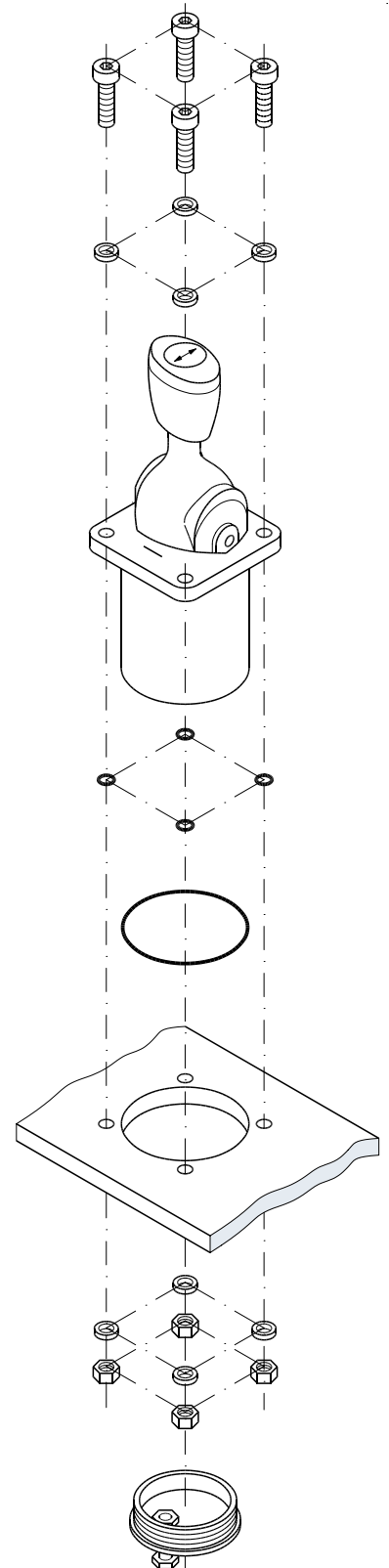

155B403.10

520L0507

E	Nødstop Emergency stop Notschalter Arrêt d'urgence
T	Fladstik A 6,3 - 0,8* Tabs A 6.3 - 0.8* Flachstecker A 6,3 - 0,8* Languettes mâles A 6,3 - 0,8*

* (DIN 46244)

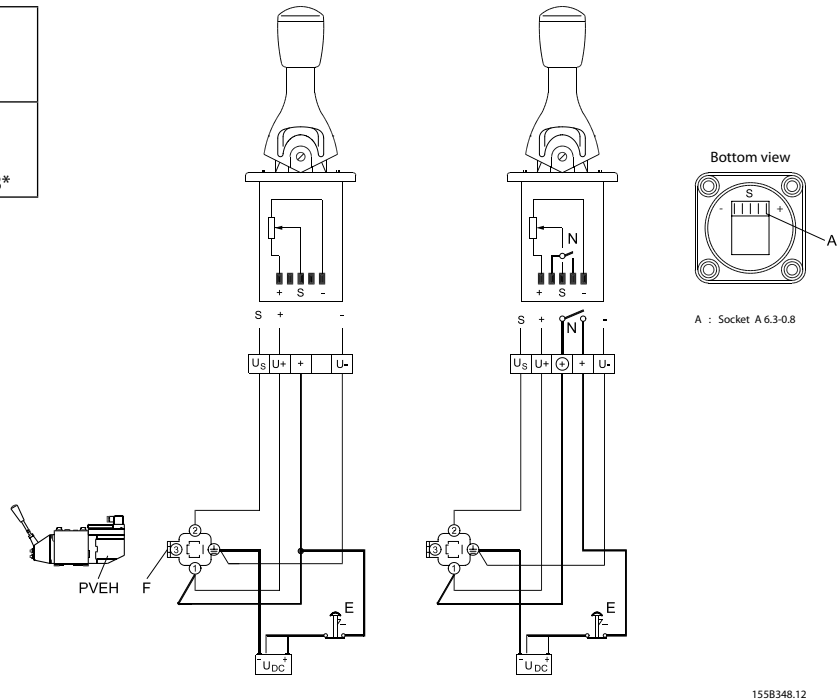

155B348.12

Signal (U_s) som funktion af håndtagsvinkel
Signal (U_s) as a function of the lever angle
Signal (U_s) als Funktion des Geberwinkels
Signal (U_s) en fonction de l'angle de levier

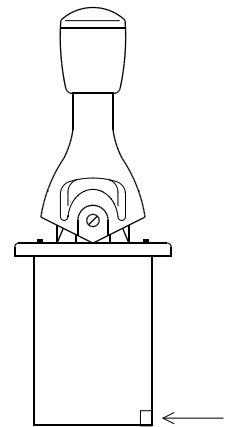
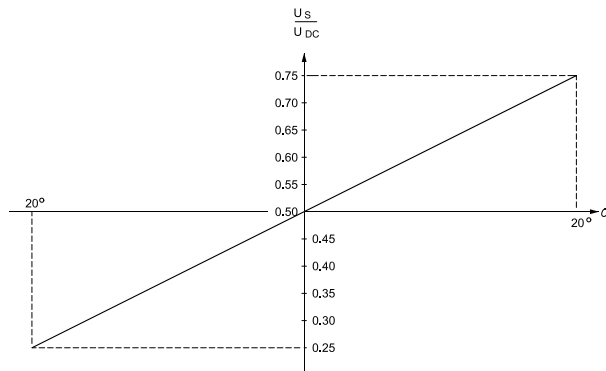

P301 225

*PVREL med holdefunktion
*PVREL with hold function
*PVREL mit Haltefunktion
*PVREL avec la fonction de maintien

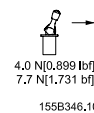

Flydestilling
Float position
Fließstellung
Position flottante

