

# SENTRY 6510 CAPACITY MONITOR

## OPERATORS MANUAL & FITTING INSTRUCTIONS

Firmware version 1.10



**TeeJet**<sup>®</sup>  
TECHNOLOGIES

A Subsidiary of  Spraying Systems Co.<sup>®</sup>

## **Copyrights**

© 2014 TeeJet Technologies. All rights reserved. No part of this document or the computer programmes described in it may be reproduced, copied, photocopied, translated, or reduced in any form or by any means, electronic or machine readable, recording or otherwise, without prior written consent from TeeJet Technologies.

## **Trademarks**

Unless otherwise noted, all other brand or product names are trademarks or registered trademarks of their respective companies or organizations.

## **Limitation of Liability**

TEEJET TECHNOLOGIES PROVIDES THIS MATERIAL "AS IS" WITHOUT WARRANTY OF ANY KIND, EITHER EXPRESSED OR IMPLIED. NO COPYRIGHT LIABILITY OR PATENT IS ASSUMED. IN NO EVENT SHALL TEEJET TECHNOLOGIES BE LIABLE FOR ANY LOSS OF BUSINESS, LOSS OF PROFIT, LOSS OF USE OR DATA, INTERRUPTION OF BUSINESS, OR FOR INDIRECT, SPECIAL, INCIDENTAL, OR CONSEQUENTIAL DAMAGES OF ANY KIND, EVEN IF TEEJET TECHNOLOGIES HAS BEEN ADVISED OF SUCH DAMAGES ARISING FROM TEEJET TECHNOLOGIES SOFTWARE.

## Table of contents

<b>INSTALLATION</b>	<b>2</b>
General overview.....	2
Electrical connections.....	4
Fitting the monitor.....	5
Fitting the junction box.....	5
Connecting the power supply.....	5
Mounting the wheel sensor.....	6
Fitting the walker pads.....	7
Connecting the walker pad cables.....	7
Fitting the sieve sensor.....	8
Position.....	8
Shortening the sensor.....	9
Connecting the sieve sensor cables.....	10
<b>OPERATION</b>	<b>11</b>
User interface.....	11
Calculation of grain loss.....	12
Grain loss calculation examples.....	12
<i>Example 1</i> .....	12
<i>Example 2</i> .....	12
<i>Example 3</i> .....	12
Rule of thumb.....	12
Rule of thumb example.....	12
Setting up the capacity monitor.....	13
Display indications.....	14
Storage of values.....	15
Supply voltage monitoring.....	15
Speed compensation.....	15
Sensor sensitivity, position and cleaning.....	15

# Sentry 6510 Capacity Monitor

## INSTALLATION

### General overview

Figure 1: System diagram

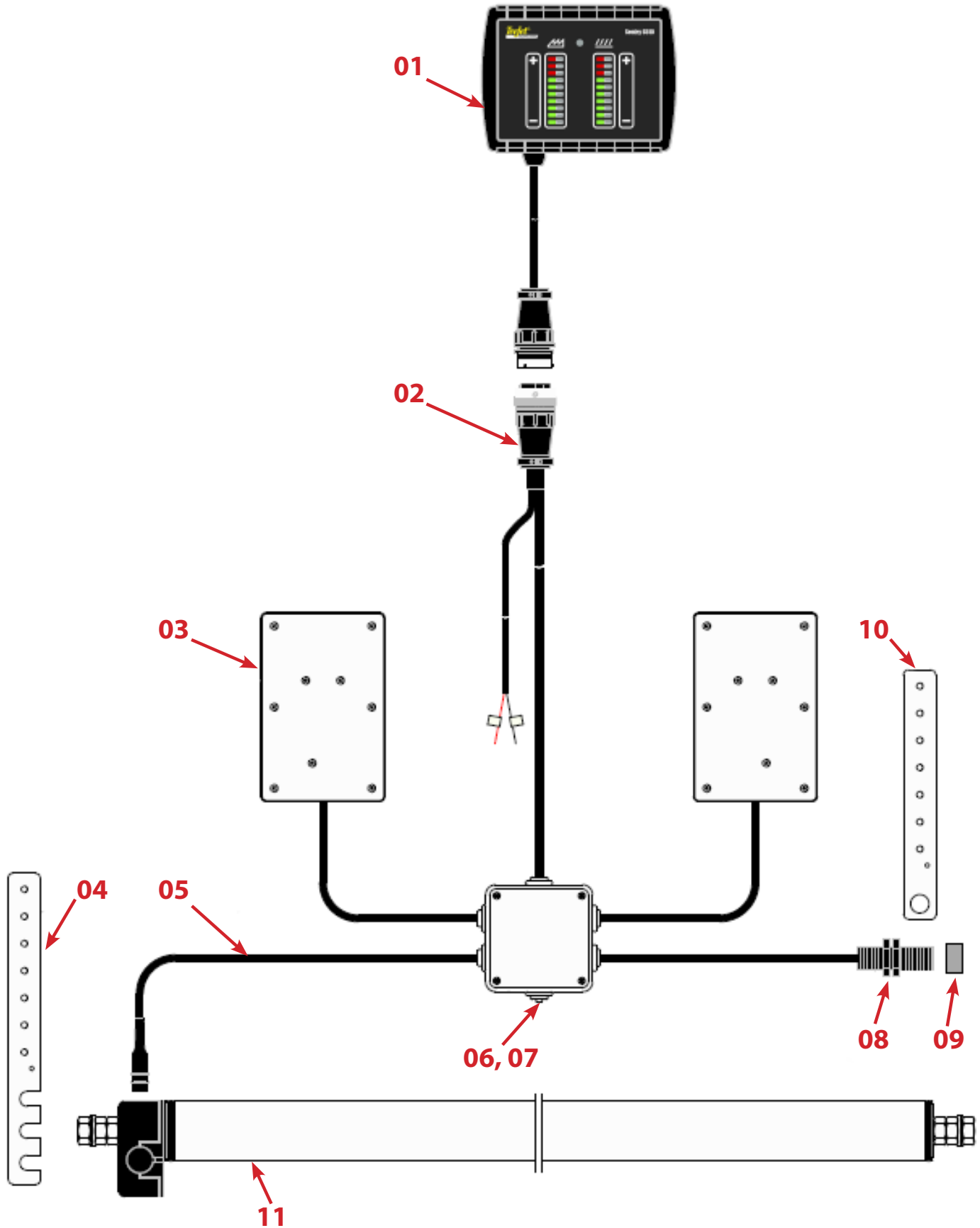

# Sentry 6510 Capacity Monitor

Item	Part number	Description
01	902-630	TeeJet Sentry 6510 Capacity Monitor
02	198-716	Main cable
03	907-012	Straw walker sensor
04	841-521	Sieve sensor bracket
05	198-312	Sieve sensor cable
06	866-012	Junction box
07	900-013	Circuit board
08	901-982	Speed sensor
09	775-803	Magnet
10	842-546	Speed sensor bracket
11	927-021	Sieve sensor

# Sentry 6510 Capacity Monitor

## Electrical connections

Figure 2: Close-up of electrical wiring

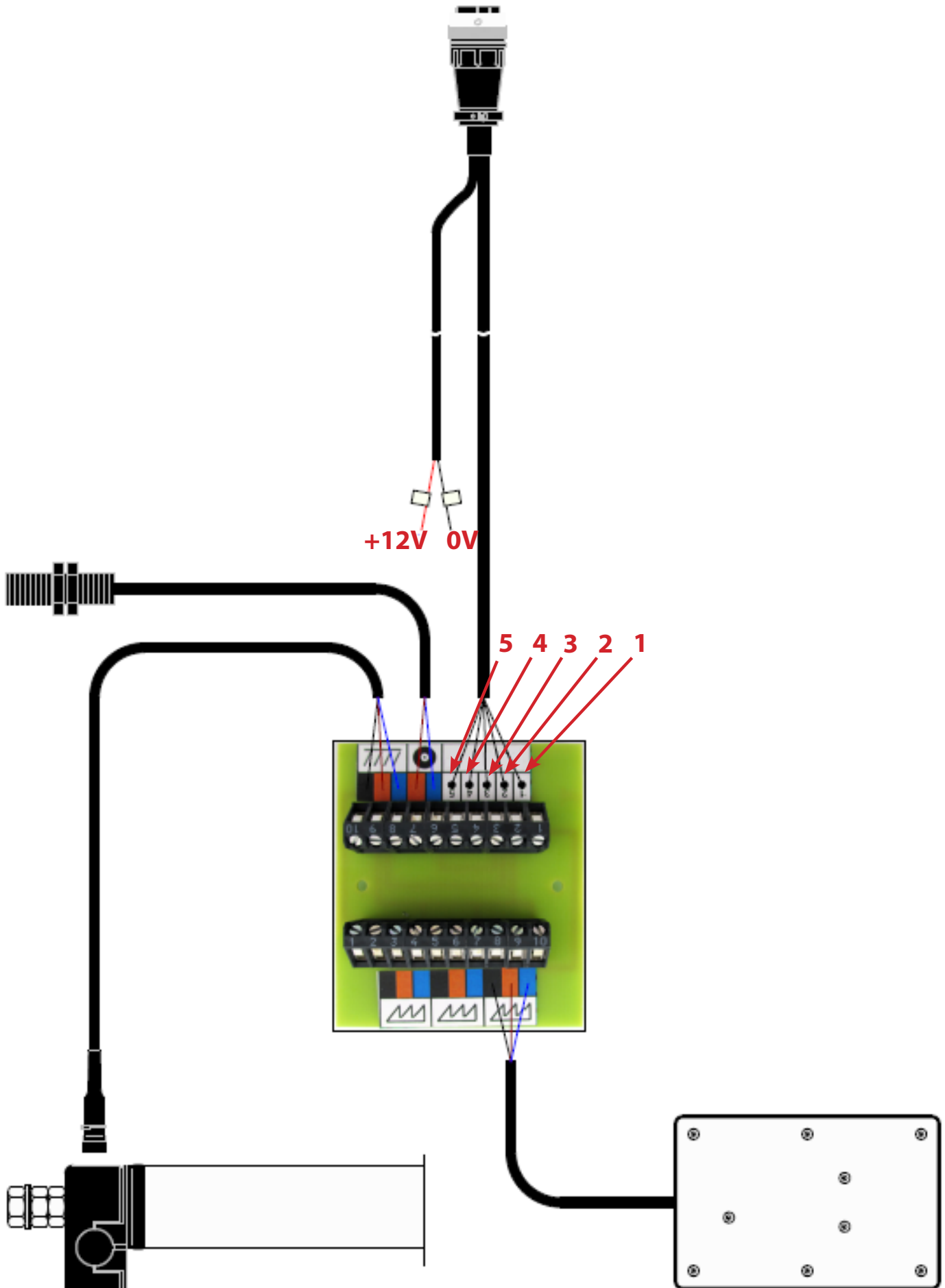

## Fitting the monitor

Place the monitor inside the driver's cab in a position where it is easy for the operator to read the display.

1. Mark the mounting position and the location for screw holes as shown in Figure 3.

Figure 3: Monitor mounting bracket position

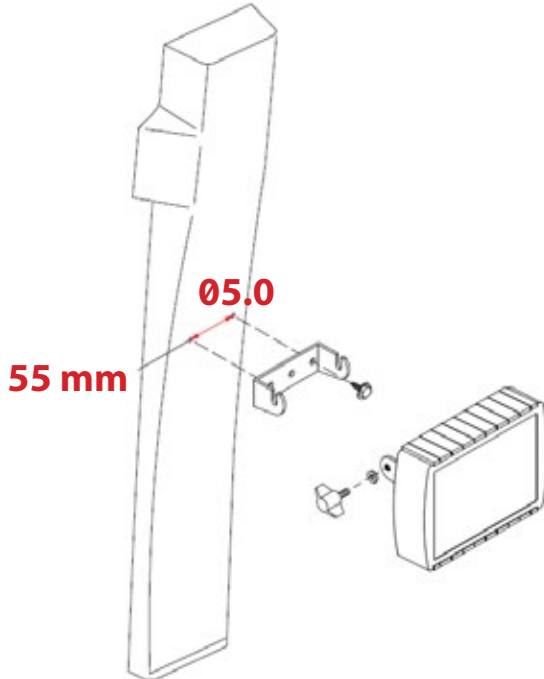

2. Drill the screw holes and mount the bracket.
3. Attach the monitor to the bracket as shown in Figure 3.

*NOTE: The Sentry 6510 Capacity Monitor uses the same connection as the LH500C Combine Computer. If the combine harvester already has an LH500C installed, simply connect the cable from the monitor to the port on the main cable.*

## Fitting the junction box

Mount the junction box at the rear of the combine harvester on the right side where it will be well-protected and accessible for connecting cabling (the main cable, shown in Figure 1, is 10 m long).

1. Lead the cable from the monitor along existing supply mains and hydraulic tubes through the hole in the junction box.

*NOTE: Beware of rotating parts, sharp edges and high temperatures (such as from exhaust).*

2. Connect the cable to the circuit board as shown in Figure 2.

## Connecting the power supply

The supply voltage is 12 Volt.

1. Connect the supply cable to 12 V such that when the combine harvest ignition is turned off, power to the monitor is also turned off.
2. Connect the red cable to the +12 V and the black cable to the ground (0V).

# Sentry 6510 Capacity Monitor

---

## Mounting the wheel sensor

Mount the wheel sensor to the frame on the inside one of the steering wheels.

Mount the magnet to the wheel hub or rim using the 20 mm support collar.

1. Screw or weld the sensor bracket.
2. Place the sensor in the bracket.
3. Turn the wheel and ensure that the distance between the sensor and the magnet is 5-8 mm.

Figure 4: Wheel sensor and magnet placement

---

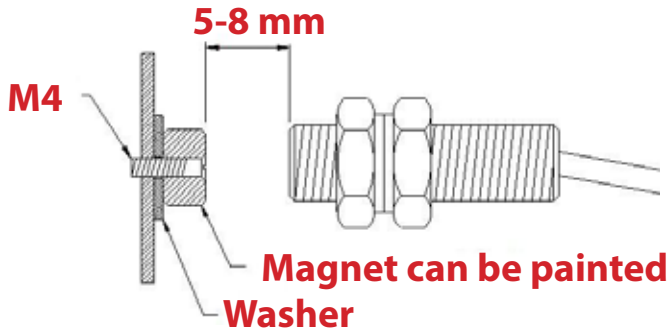

4. Put the sensor cable to the junction box and connect to the circuit board as shown in Figure 2.
5. Use cable ties to fix the cable so it will not be pinched or worn during operation.



## Fitting the walker pads

Mount the two walker pads at the rear of the two outside straw walkers.

*NOTE: Account for any reinforcements and walker extensions when positioning the walker pads.*

1. Stick the supplied adhesive templates on the underside of the walkers with the arrow pointing to the rear of the walkers.
2. Drill the holes as shown on the templates.

Figure 5: Walker pad placement

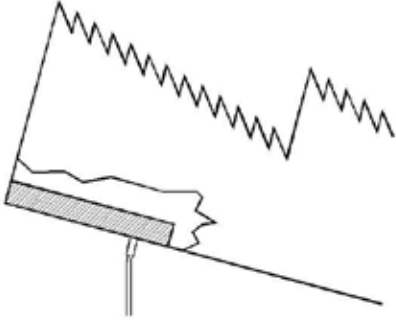

## Connecting the walker pad cables

The straw walker cable must contain a loop between the walker and the combine harvester body. The loop must be large enough to “capture” the circular movement of the straw walkers without stressing the cable.

Figure 6: Walker pad cable loop

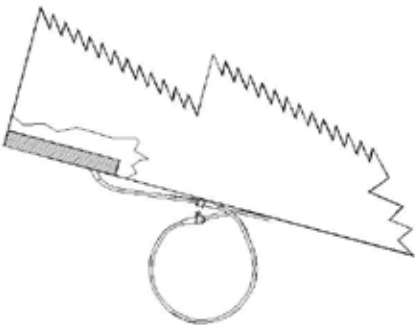

1. Attach the cable to the underside of the straw walker approximately 20 cm from the point at which the cable comes through the walker. Attach the fastener carefully to preserve cable life.

Figure 7: Walker pad cable attachment

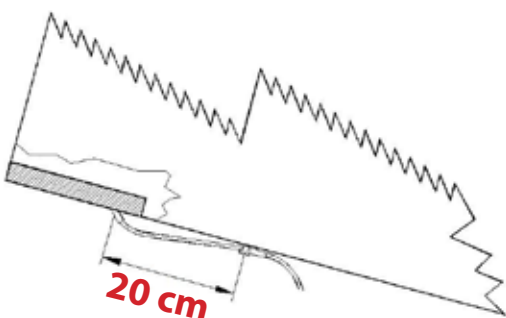

# Sentry 6510 Capacity Monitor

- Turn the straw walker to its lowest position and mark the side of the combine harvester (position A in Figure 9) at a right angle to the cable fastener.

Figure 8: Straw walker mark angle

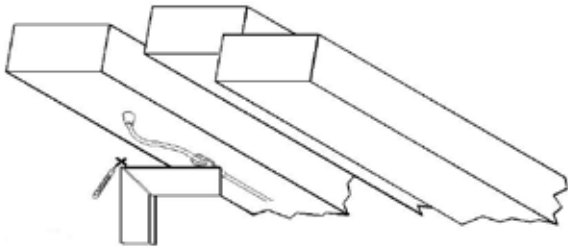

- Turn the straw walker to the highest position and mark the side of the combine harvester (B).
- To determine the length of cable needed to make the loop, measure the distance (L) between marks (A) and (B) and multiply by three.

Figure 9: Straw walker loop length calculation

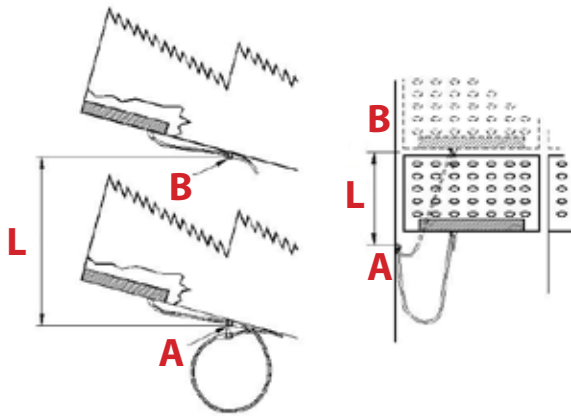

- Make a loop of from the calculated length of cable and attach the cable fastener 20 mm under the lower mark.
- Repeat for both walker pads.
- Connect the cables to the junction box, avoiding any sharp edges, pinch points or other sources of cable damage, and fasten to the combine harvester using supplied cable ties.
- Connect the cables to the circuit board as shown in Figure 2.

## Fitting the sieve sensor

### Position

The sieve sensor must be fitted so it can measure the grain loss behind the sieves across the entire width of the sieves. The best sieve sensor position for normal grain types is 120 mm behind the rear edge of the sieves and 50 mm under the sieves (measured from the centre of the tube).

Figure 10: Sieve sensor bracket placement

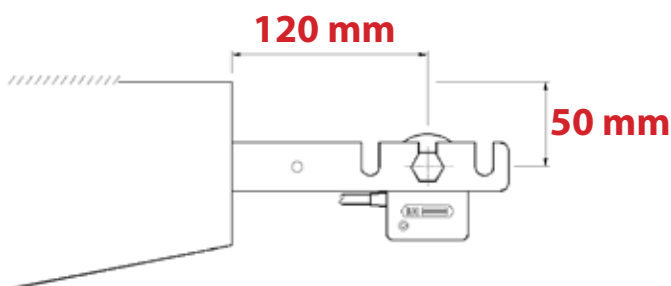

The supplied brackets have three slits. When fitting, measure from the middle slit to allow the sensor to be moved depending on crop type. For example, the sensor can be moved closer when harvesting a crop where little air is blown under the sieves, such as oilseed rape, or the sensor can be moved further away when harvesting a crop that requires more air to be blown under the sieves.

On some combine harvesters, it may not be possible to fit the sensor in the recommended position due to placement of other parts, such as an adjustment handle. In these cases, the sensor can be mounted higher or lower than 50 mm under the sieves. In any case, the centre of the sensor must not be higher than the edge of the sieve, or lower than 100 mm under the sieve.

Figure 11: Alternate sieve sensor bracket placement

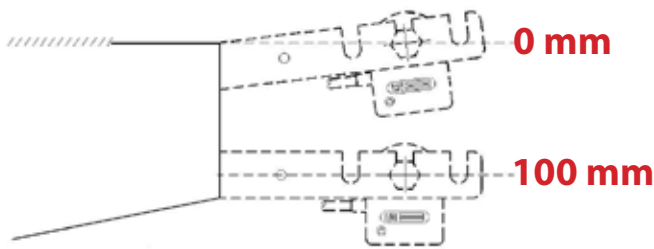

Once the position is determined, weld or bolt the brackets to the sieves so that they are stable and do not shake.

## Shortening the sensor

The steel tube can be shortened to the distance between the two brackets.

1. Loosen all of the nuts and remove the rubber bung opposite the plug.
2. Loosen the Allen screw and remove the plastic spacer from the tube.

Figure 12: Sensor tube nuts

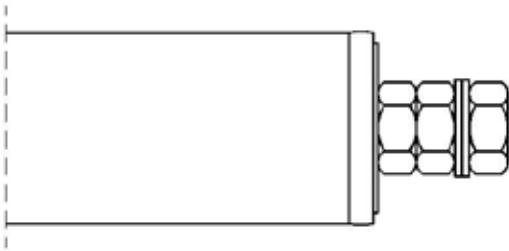

3. Measure the distance between the brackets ( $x$ ), and subtract 22 mm, to learn the distance between the two washers ( $L$ ).

Figure 13: Sensor tube length calculation

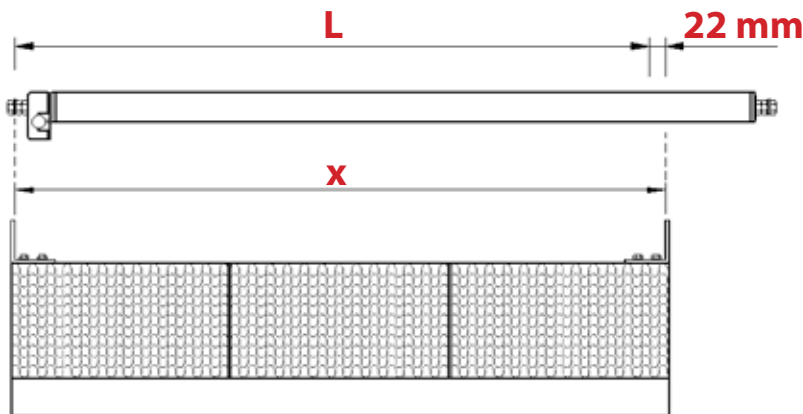

4. Cut the tube with a hacksaw.

**NOTE:** To avoid damaging the tube, do not use a vice when cutting the tube. Remove all metal shavings from the tube before replacing the rubber bung.

5. Position the plastic spacer approximately 5 mm from the end of the bolt in the rubber bung.
6. Replace the rubber bung so that approximately 5 mm of the bung protrudes from the tube.

# Sentry 6510 Capacity Monitor

---

Figure 14: Bung and spacer placement

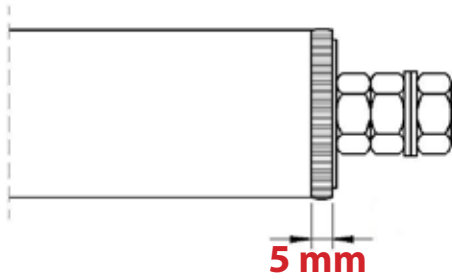

7. Tighten the nuts so that the rubber swells slightly.

*NOTE: The bolts in the bung must not touch the plastic spacer.*

## Connecting the sieve sensor cables

1. Connect the plug to the sensor.
2. Fasten the cable to the bracket using a cable fastener.

Figure 15: First sieve sensor cable fastener

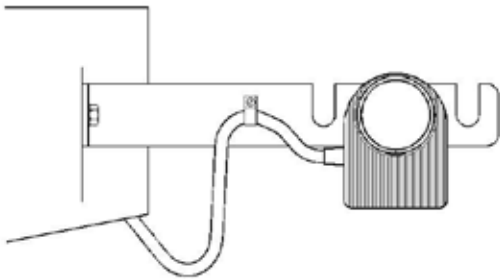

3. Make a bend in the cable large enough to “capture” the movement of the sieves.
4. Fit another cable fastener to the side of the machine.

Figure 16: Second sieve sensor cable fastener

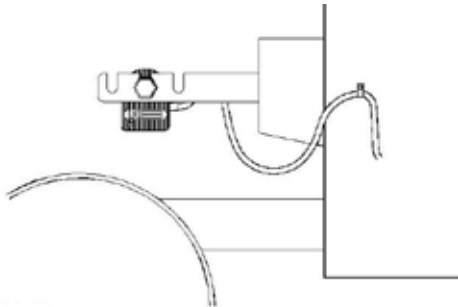

5. Connect the cable to the junction box, avoiding any sharp edges, pinch points or other sources of cable damage, and fasten to the combine harvester using supplied cable ties.
6. Connect the cables to the circuit board as shown in Figure 2.

## OPERATION

### User interface

Figure 17: User interface buttons

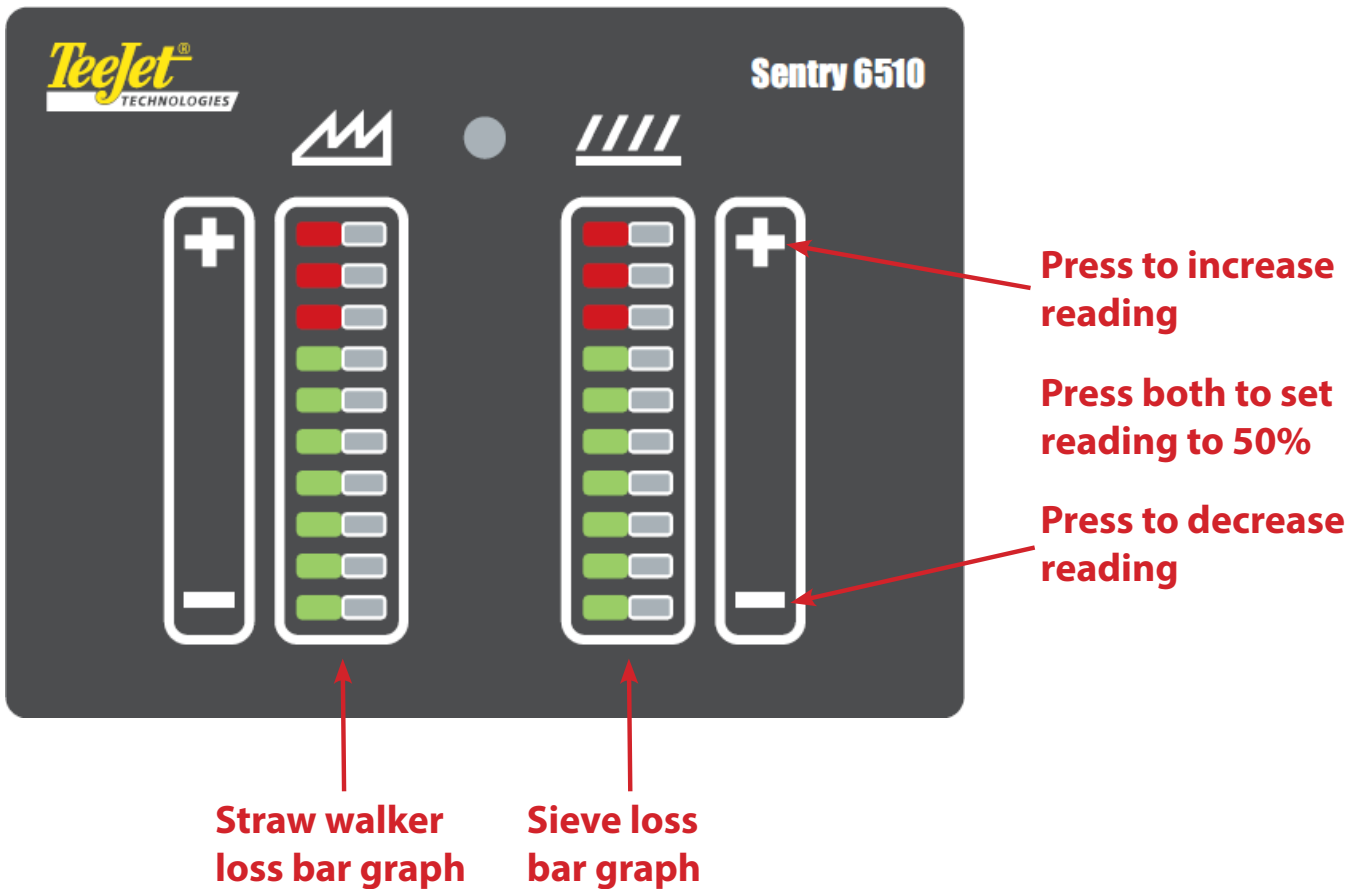

The LEDs on each bar graph indicate the current relative loss value as measured by the straw walker sensor and the sieve sensor.

When the monitor is turned on, the bottom LED in each graph will be on, indicating the power is on and the system is running as expected.

Press the + and - buttons to change the sensor gain, which in turn alters the reading on one of the graphs up or down by one light. Hold the button to continue raising or lowering the gain.

Press + and - simultaneously to set the reading to the middle (50%).

These cases will prevent changing gains:

- If no loss is detected at all, the reading cannot be changed at all
- If the reading is above ten, the reading cannot be increased
- If the reading is below one, the reading cannot be decreased
- If the loss is very low, it may not be increased to the maximum, but will be adjustable to the highest possible value

**NOTE:** To ensure that the grain loss readings are as accurate as possible, it is recommended to check the reading of the monitor against actual grain loss frequently, as described in **Calculation of grain loss**.

# Sentry 6510 Capacity Monitor

## Calculation of grain loss

This table indicates the number of lost seeds per metre of straw behind the combine harvester when the loss is 1% and the field yields 4000 kg/ha.

Width of cut		Barley	Oats	Wheat	Rye
Centimetre	Foot	25 seeds=1 g	28 seeds=1 g	21 seeds=1 g	25 seeds=1 g
100		100	112	84	100
180	6	180	201	161	180
240	8	240	268	201	240
265	8½	265	296	222	265
300	10	300	336	252	300
360	12	360	403	302	360
420	14	420	470	352	420
450	15	450	504	378	450
510	17	510	571	428	510
570	18	570	638	478	570

If the yield is significantly different from 4000 kg/ha, calculate the percentage loss by hand.

1. Place a piece of canvas under the sieves to collect lost seeds.
2. Harvest exactly one metre.
3. Count the lost seeds collected on the canvas. Disregard any seeds lying in the field before beginning to harvest.
4. Divide the actual number of seeds lost by the expected number of seeds lost from the table above.
5. Divide 4000 kg/ha by the actual yield in kilograms per hectare.
6. Multiply the results of these two operations to find the actual percentage loss.

## Grain loss calculation examples

### Example 1

When harvesting barley with a 360 cm wide cut in a field yielding 4000 kg/ha, and 220 lost seeds are collected:

$$\text{Loss} = 220/350 = 0.6\%$$

### Example 2

When harvesting barley with a 360 cm wide cut in a field yielding 4800 kg/ha, and 220 lost seeds are collected:

$$\text{Loss} = 220/360 \times 4000/4800 = 0.5\%$$

### Example 3

When harvesting wheat with an 265 cm wide cut in a field yielding 5000 kg/ha, and 200 lost seeds are collected:

$$\text{Loss} = 200/222 \times 4000/5000 = 0.7\%$$

## Rule of thumb

From the grain loss table above it can be concluded that for every centimetre of cut width, about one seed will be lost per metre driven.

Since lost seeds usually land in a track about one metre wide, the number of lost seeds listed in the table covers about one square metre.

Since the human hand is on average about 1/100 m<sup>2</sup>, acceptable loss is about 1/100 of the loss indicated in the grain loss table.

## Rule of thumb example

A combine harvester with a 510 cm cut width is harvesting barley in a field yielding 4000 kg/ha.

The grain loss table indicates an acceptable 1% loss in 510 seeds per metre.

When holding the hand over the lost seeds, an acceptable number of seeds under the hand would be:

$$510/100 = 5.1 \text{ seeds}$$

## Setting up the capacity monitor

Not even the best capacity indicator can prevent grain from being lost. The purpose of the monitor is to inform the operator of the approximate amount of grain being lost.

It is also important to understand that the loss readings from the monitor are not absolute measurements, but are instead meant to indicate how the loss is perceived when harvesting variables change.

For example, if the grain lost doubles but speed does not change, the reading on the monitor doubles. If, however, the grain lost doubles and the speed doubles, the reading on the monitor is unchanged. If the grain lost is unchanged and the speed doubles, the reading on the monitor is halved.

To obtain the most accurate relative readings, set up the monitor as follows:

1. Adjust the combine harvester to an acceptable loss without using the capacity monitor, following the guidelines in **Calculation of grain loss** and **Rule of thumb**.
2. Set the combine harvester to a consistent speed.
3. While driving, simultaneously press the + and - buttons on the straw walker loss bar graph, then release them to set the bar graph to the middle of the scale (50%).

Figure 18: Sieve loss buttons

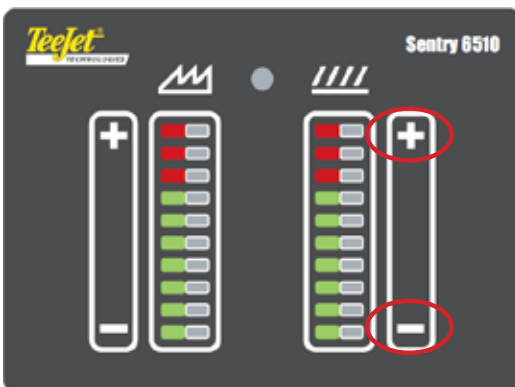

4. While driving, simultaneously press the + and - buttons on the sieve loss bar graph, then release them to set the bar graph to the middle of the scale (50%).

Figure 19: Straw walker loss buttons

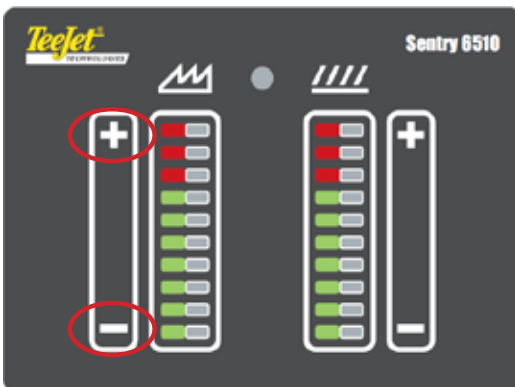

# Sentry 6510 Capacity Monitor

## Display indications

A correctly adjusted monitor will indicate with the LEDs both the relative grain loss and when the combine harvester capacity is being fully utilized. Figure 20 describes the conditions that different readings indicate.

Figure 20: LED loss and capacity indications

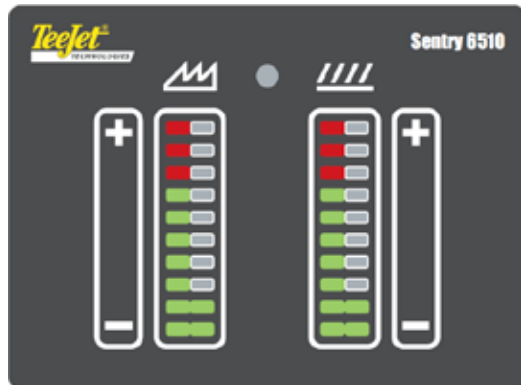

- Both displays at bottom of scale
- No loss
- You can speed up (higher capacity)

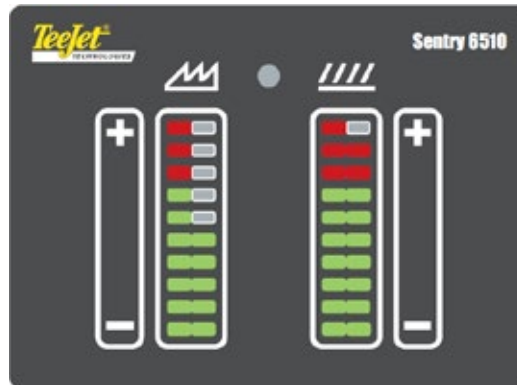

- Loss over the sieves
- Too much air or blocked sieves

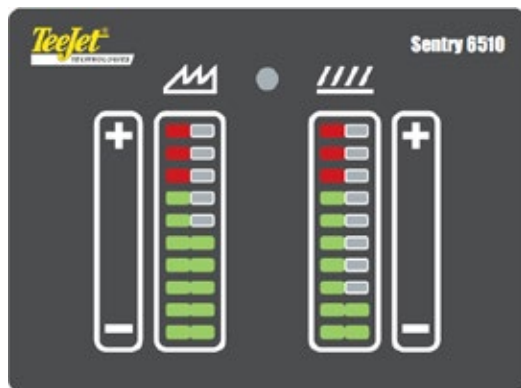

- No or intermittent loss over the sieves
- Too little air under the sieves

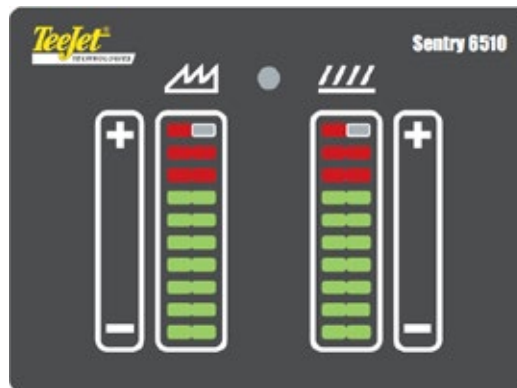

- Both displays at top of scale
- Too much loss
- Slow down

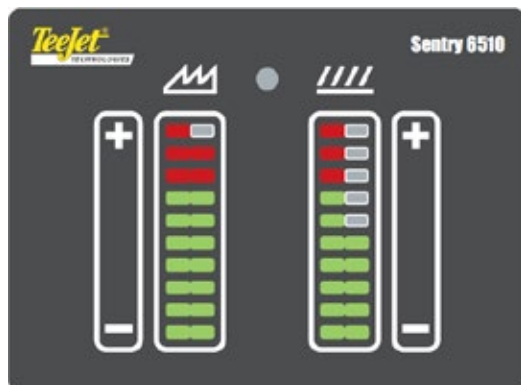

- Loss over the straw walkers
- Straw walkers overloaded
- Slow down



## Storage of values

When + or - is pressed, the gain for both graphs are saved to the monitor. When the monitor is turned off, these gain values are preserved. When the monitor is restarted, it begins working at the gain settings applied before power off.

## Supply voltage monitoring

The monitor constantly checks to ensure that the power supply voltage is between 8-16 Volts.

A supply voltage outside of this range could cause inaccurate readings. If the voltage is outside of this range, the bottom LED on each graph will flash, the top LED on each graph will be continuously lit and the monitor will cease reporting grain loss readings.

When the supply voltage returns to the acceptable range, the monitor will return to normal operating and grain loss reading resumes.

## Speed compensation

This monitor can be used without a speed sensor. Without a speed sensor, the monitor automatically assumes a speed of 5 km per hour. The grain loss is reported as a "loss per time" value, and this mode of operation is known as a "Grain Loss Monitor".

As the speed of a combine harvester increases, the frequency of grain striking the loss sensors increases, which can lead to an inflated "loss per time" value.

When the monitor is connected to a speed sensor, the monitor automatically compensates for the measured forward speed, so that the indicated loss remains constant for the area covered.

In this case, the grain loss reported is a "loss per area" value, and this mode of operation is known as a "Capacity Indicator".

The monitor automatically detects the type of speed sensor connected. No speed sensor calibration is needed.

The monitor supports these sensor ranges:

- Wheel sensors with resolution from 50 impulses/100 m to approximately 150 impulses/100 m, for a speed range of 1 km/h to 25 km/h. Speeds below 1 km/h report as 1 km/h.
- GPS or radar sensors with resolution of 10000 impulses/100 m to approximately 15000 impulses/100 m, for a speed range of 1 km/h to 25 km/h. Speeds below 1 km/h report as 1 km/h.

*NOTE: If no speed impulses are received for eight seconds, the monitor will switch to "loss per time" mode and will assume a speed of 5 km/h. GPS or radar sensors at speeds below 0.4 km/h may provide unstable readings.*

To preserve accuracy of grain loss readings, do not use sensors with lower resolutions than indicated above. It is possible to use sensors with higher resolutions, but this may result in artificially limited maximum usable speeds.

## Sensor sensitivity, position and cleaning

In most cases, the straw walker sensor sensitivity should not be changed from the NORM position. If a crop has exceptionally large seeds, sensitivity may be adjusted to MIN, or if the crop has exceptionally small seeds, sensitivity can be adjusted to MAX, but in general it is preferable to control the readings with the gain on the monitor.

Move the sieve sensor among the slots in the brackets in order to keep the sieve sensor in the loss stream.

Sensors often become covered in a layer of dirt during use, particularly when harvesting green or moist crops. Clean this dirt from the sensor with hand cleaner as often as required.

# SENTRY 6510 CAPACITY MONITOR

## OPERATORS MANUAL & FITTING INSTRUCTIONS

---



[www.teejet.com](http://www.teejet.com)

A Subsidiary of  *Spraying Systems Co.*

990-630-EN-A4 R0 English  
© TeeJet Technologies 2014