



Approved Performance from Rexnord

Roller chains | European type



Roller chains - European type

Approved Performance from Rexnord.

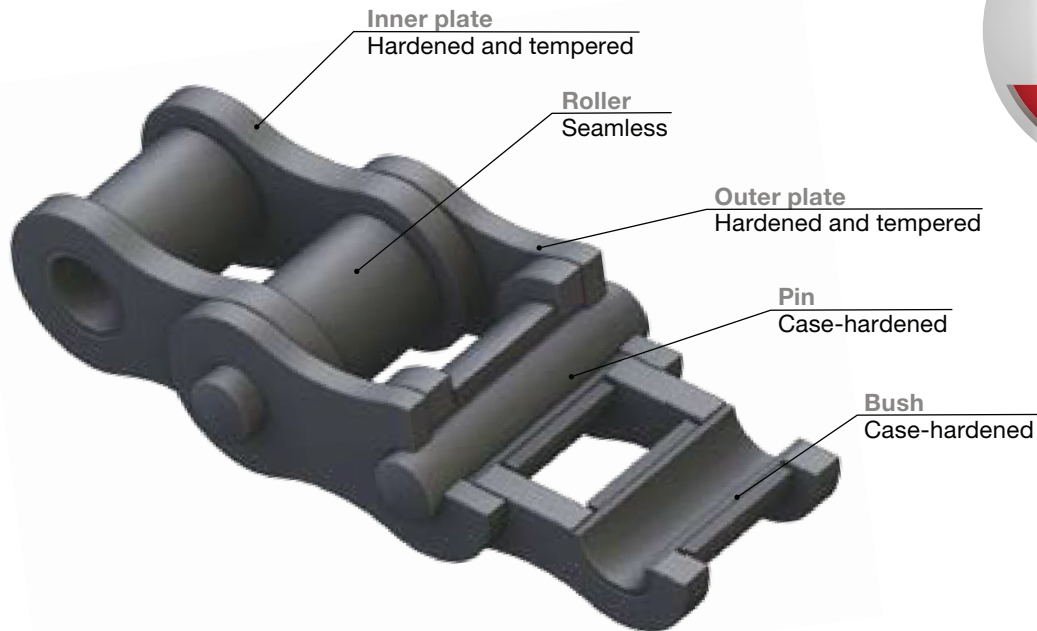

APPLICATIONS

- Light and medium duty
- Agricultural machinery, wood processing
- Textile industry

CHARACTERISTICS

- Established brand name
- Fulfils ISO quality requirements
- Rexnord guarantees the achievement of performance requirements

ADVANTAGES

- Good cost-benefit ratio
- Good availability
- Robust quality

LUBRICATION

- Contains no heavy metals
- Fulfils REACH requirements

Roller chains - European type

Approved Performance from Rexnord.

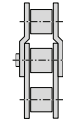

Simplex roller chains



Proven performance

- Fulfills ISO quality requirements
- Rexnord guarantees the achievement of performance requirements
- Optimum choice for light and medium duty



Purchasing policy

- Suppliers must comply with local environmental laws
- Suppliers must comply with Rexnord's ethical policy and internal guidelines
- Suppliers must take local environmental policy into account



Economical

- Good cost-benefit ratio
- Good availability



Simplex roller chains, ISO 606

Chain No.	Pitch		Width between inner plates		Roller diameter		Pin diameter		Width over inner link		Plate depth		Transverse pitch		Pin length		Connecting pin length		Bearing area		Required min. tensile strength DIN/ISO		Weight		Loose parts					
	p		b ₁ min.		d ₁ max.		d ₂ max.		b ₂ max.		g max.		e		a ₁ max.		a ₃ max.		A		F _u		q		A	B	C	E	L	S
	inch	mm	mm	mm	mm	mm	mm	mm	mm	mm	mm	mm	mm	mm	mm	mm	mm	mm	mm	mm	cm ²	N	kg/m							
04 B-1	0.235	6.0	2.80	4.00	1.85	4.10	5.0	-	7.4	10.3	0.08	3 000	0.1			x	x													
05 B-1	0.315	8.0	3.00	5.00	2.31	4.77	7.1	-	8.6	11.7	0.11	4 400	0.2			x	x													
06 B-1	0.375	9.525	5.72	6.35	3.28	8.53	8.2	-	13.5	16.8	0.28	8 900	0.4			x	x	x												
08 B-1	0.50	12.7	7.75	8.51	4.45	11.30	11.8	-	17.0	20.9	0.50	17 800	0.7			x	x	x												
10 B-1	0.625	15.875	9.65	10.16	5.08	13.28	14.7	-	19.6	23.7	0.67	22 200	0.9			x	x	x	x											
12 B-1	0.75	19.05	11.68	12.07	5.72	15.62	16.2	-	22.7	27.3	0.89	28 900	1.2			x	x	x	x											
16 B-1	1.00	25.4	17.02	15.88	8.28	25.45	21.0	-	36.1	41.5	2.11	60 000	2.7			x	x	x	x											
20 B-1	1.25	31.75	19.56	19.05	10.19	29.01	26.4	-	43.2	49.3	2.96	95 000	3.6															x	x	
24 B-1	1.50	38.1	25.40	25.40	14.63	37.92	33.4	-	53.4	60.0	5.55	160 000	6.7															x	x	
28 B-1	1.75	44.45	30.99	27.97	15.80	46.58	37.0	-	65.1	72.5	7.36	200 000	8.7															x	x	
32 B-1	2.00	50.8	30.99	29.21	17.81	45.57	42.2	-	67.4	75.3	8.12	250 000	10.0															x	x	

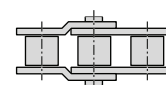
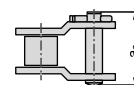
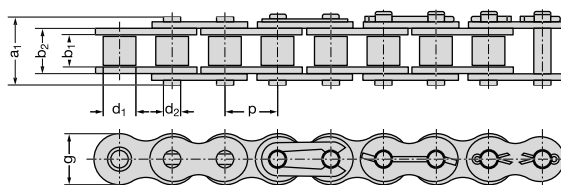

B
inner link

A
outer link

E
connecting link with clip

S
connecting link with cotter

L
cranked link with cotter

C
double cranked link

Roller chains - European type

Approved Performance from Rexnord.

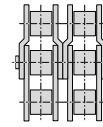

Duplex roller chains



Proven performance

- Fulfills ISO quality requirements
- Rexnord guarantees the achievement of performance requirements
- Optimum choice for light and medium duty



Purchasing policy

- Suppliers must comply with local environmental laws
- Suppliers must comply with Rexnord's ethical policy and internal guidelines
- Suppliers must take local environmental policy into account



Economical

- Good cost-benefit ratio
- Good availability

Duplex roller chains, ISO 606

Chain No.	Pitch		Width between inner plates	Roller diameter	Pin diameter	Width over inner link	Plate depth	Transverse pitch	Pin length	Connecting pin length	Bearing area	Required min. tensile strength DIN / ISO	Weight	Loose parts							
	p	p												b ₁ min.	d ₁ max.	d ₂ max.	b ₂ max.	g max.	e	a ₁ max.	a ₃ max.
	inch	mm	mm	mm	mm	mm	mm	mm	mm	mm	mm	cm ²	N	kg/m							
06 B-2	0.375	9.525	5.72	6.35	3.28	8.53	8.2	10.24	23.8	27.1	0.56	19 600	0.8			x	x	x			
08 B-2	0.50	12.7	7.75	8.51	4.45	11.30	11.8	13.92	31.0	34.9	1.01	31 100	1.4			x	x	x			
10 B-2	0.625	15.875	9.65	10.16	5.08	13.28	14.7	16.59	36.2	40.3	1.35	44 500	1.8			x	x	x	x		
12 B-2	0.75	19.05	11.68	12.07	5.72	15.62	16.2	19.46	42.2	46.8	1.79	57 800	2.3			x	x	x	x		
16 B-2	1.00	25.4	17.02	15.88	8.28	25.45	21.0	31.88	68.0	73.4	4.21	106 000	5.3			x	x	x	x		
20 B-2	1.25	31.75	19.56	19.05	10.19	29.01	26.4	36.45	79.7	85.8	5.91	170 000	7.0					x	x		
24 B-2	1.50	38.1	25.40	25.40	14.63	37.92	33.4	48.36	101.8	108.4	11.10	280 000	13.2					x	x		
28 B-2	1.75	44.45	30.99	27.97	15.80	46.58	37.0	59.56	124.7	132.1	14.72	360 000	17.5					x	x		
32 B-2	2.00	50.8	30.99	29.21	17.81	45.57	42.2	58.55	126.0	133.9	16.23	450 000	19.5					x	x		

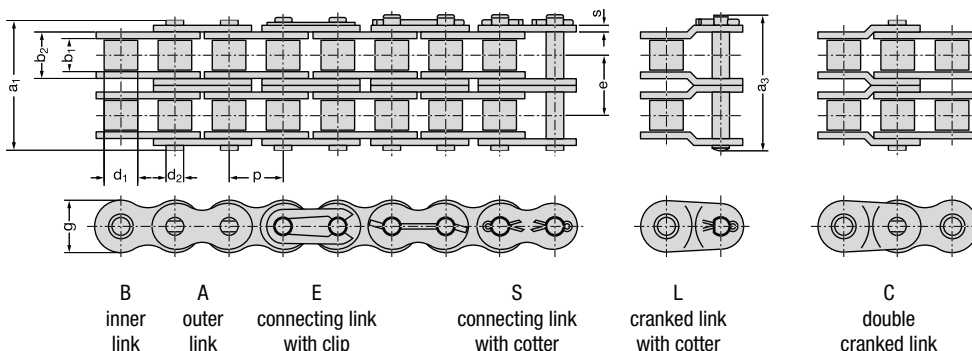

Roller chains - European type

Approved Performance from Rexnord.

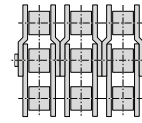

Triplex roller chains



Proven performance

- Fulfills ISO quality requirements
- Rexnord guarantees the achievement of performance requirements
- Optimum choice for light and medium duty



Purchasing policy

- Suppliers must comply with local environmental laws
- Suppliers must comply with Rexnord's ethical policy and internal guidelines
- Suppliers must take local environmental policy into account



Economical

- Good cost-benefit ratio
- Good availability



Triplex roller chains, ISO 606

Chain No.	Pitch		Width between inner plates		Roller diameter	Pin diameter	Width over inner link	Plate depth	Transverse pitch	Pin length	Connecting pin length	Bearing area	Required min. tensile strength DIN/ISO	Weight	Loose parts					
	p		b ₁ min.	d ₁ max.	d ₂ max.	b ₂ max.	g max.	e	a ₁ max.	a ₃ max.	A	F _u	q	A	B	C	E	L	S	
	inch	mm	mm	mm	mm	mm	mm	mm	mm	mm	mm	cm ²	N	kg/m						
06 B-3	0.375	9.525	5.72	6.35	3.28	8.53	8.2	10.24	34.0	37.3	0.84	24 900	1.2			x	x	x		
08 B-3	0.50	12.7	7.75	8.51	4.45	11.30	11.8	13.92	44.9	48.8	1.51	44 500	2.1			x	x	x		
10 B-3	0.625	15.875	9.65	10.16	5.08	13.28	14.7	16.59	52.8	56.9	2.02	66 700	2.7			x	x	x	x	
12 B-3	0.75	19.05	11.68	12.07	5.72	15.62	16.2	19.46	61.7	66.3	2.68	86 700	3.4			x	x	x	x	
16 B-3	1.00	25.4	17.02	15.88	8.28	25.45	21.0	31.88	99.9	105.3	6.32	160 000	7.9			x	x	x	x	
20 B-3	1.25	31.75	19.56	19.05	10.19	29.01	26.4	36.45	116.1	122.2	8.87	250 000	10.4					x	x	
24 B-3	1.50	38.1	25.40	25.40	14.63	37.90	33.4	48.36	150.2	156.8	16.64	425 000	19.7					x	x	
28 B-3	1.75	44.45	30.99	27.97	15.80	46.58	37.0	59.56	184.3	191.7	22.08	530 000	26.1					x	x	
32 B-3	2.00	50.8	30.99	29.21	17.81	45.57	42.2	58.55	184.5	192.4	24.35	670 000	29.0					x	x	

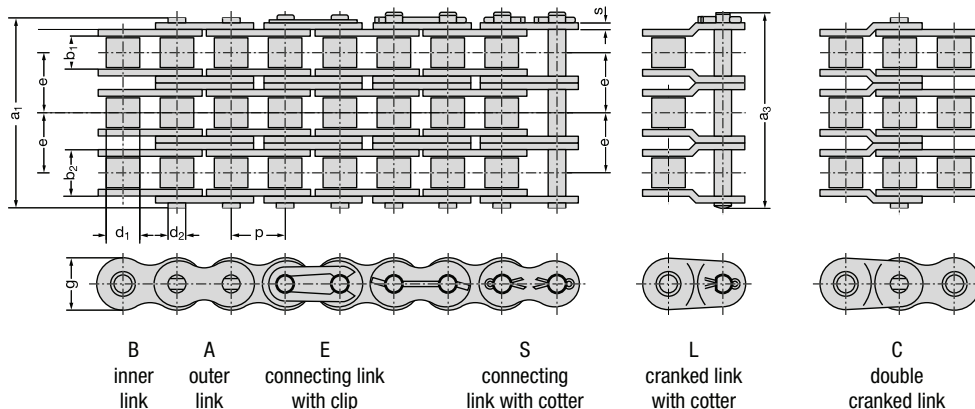

Overview Rexnord roller chains

Roller Chains

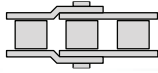

REXNORD
RexPro
RexPro lubrication
improved wear resistance
high fatigue resistance

- Outstanding protection against corrosion and wear
- Unique protection against chain joint stiffness
- Extremely eco-friendly

REXNORD
RexAthletic
good loading capacity
extended lubrication intervals

- Durable and low-maintenance
- Longer servicing intervals
- High loading capacity

REXNORD
RexCarbon
no lubrication
low noise

- Maintenance-free
- Low noise
- Eco-friendly

REXNORD
RexPlus
excellent corrosion resistance
high reliability

- Excellent resistance to rust and acids
- Highly reliable
- Fulfills hygiene requirements
- NSF H1 certification

REXNORD
RexPlusCarbon
no lubrication
excellent corrosion resistance

- Combination of RexPlus and RexCarbon
- Excellent resistance to rust and acids
- Maintenance-free
- NSF H1 certification

REXNORD
RexHiPro
good corrosion resistance
excellent loading capacity

- Outstanding corrosion resistance
- Long service life
- High loading capacity

Link-Belt
a brand of
REXNORD

- The optimum choice for light and medium duty
- Good cost-benefit ratio
- High availability

REXNORD
RexProX
RexPro lubrication
improved wear resistance
high fatigue resistance

- Extremely high loading capacity
- Long service life
- Outstanding protection against corrosion and wear

Leaf Chains

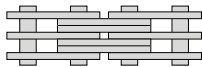

REXNORD
RexPro
RexPro lubrication
improved wear resistance
high fatigue resistance

- Outstanding protection against corrosion and wear
- Unique protection against chain joint stiffness
- Extremely eco-friendly

REXNORD
RexHiPro
good corrosion resistance
excellent loading capacity

- Outstanding corrosion resistance
- Long service life
- High loading capacity

REXNORD
RexAthletic
good loading capacity
extended lubrication intervals

- Durable and low-maintenance
- Longer servicing intervals
- High loading capacity
- Extreme wear resistance for double-length service life

REXDL
a brand of
REXNORD

- The optimum choice for light and medium duty
- Good cost-benefit ratio
- Good availability