

LA36 ACTUATOR



To learn more about LINAK, please visit:
WWW.LINAK.COM

Contents

Preface	5
Safety instructions	6
Important information	6
Warnings	7
Recommendations	7
Declaration of conformity	7-8
Misc. on the TECHLINE® actuator system	
Warranty	9
Maintenance	9
Maintenance of spherical eyes	9
Specifications	10
Usage	10
Mounting guidelines	11-12
Mounting of cables	13
Manual hand crank	14
Electrical installation	
Actuator without feedback: Connection diagram and I/O specifications	15
Actuator with endstop signal output: Connection diagram and I/O specifications	16-17
Actuator with relative positioning - Dual Hall: Connection diagram and I/O specifications ..	18-19
Actuator with endstop signals and relative positioning - Dual Hall: Connection diagram and I/O Specifications	20-21
Actuator with relative positioning - Single Hall: Connection diagram and I/O specifications	22-23
Actuator with endstop signals and relative positioning - Single Hall: Connection diagram and I/O specifications	24-25
Actuator with absolute positioning - Analogue feedback: Connection diagram and I/O specifications	26-27
Actuator with endstop signals and absolute positioning - Analogue feedback Connection diagram and I/O specifications	28-29
Actuator with absolute positioning - Mechanical potentiometer feedback: Connection diagram and I/O specifications	30-31
Actuator with endstop signals and absolute positioning - Mechanical potentiometer feedback: Connection diagram and I/O specifications	32-33
Actuator with absolute positioning - PWM: Connection diagram and I/O specifications	34-35
Actuator with endstop signals and absolute positioning - PWM: Connection diagram and I/O specifications	36-37
Actuator with old CS36 (H-bridge) version - Dual Hall: Connection diagram and I/O specifications	38-39
Actuator with old CS36 (H-bridge) version - Endstop signals: Connection diagram and I/O specifications	40-41
Actuator with IC Basic: Connection diagram and I/O specifications	42-44
Actuator with IC Advanced - with BusLink: Connection diagram and I/O specifications	45-47
Correct wiring of Power GND and Signal GND for IC Basic and IC Advanced	48

Contents

Actuator with Parallel: Connection diagram and I/O specifications	49-51
The parallel system	52-53
System Monitoring for Parallel	54
Alignment of the parallel actuator system	54
Troubleshooting	55-56
Actuator dimensions	57-58
Speed and current curves	59-60
Repair and spare parts	61
Main groups of disposal	61
Label for LA36	62
Key to symbols	63
LINAK application policy	63
Addresses	64

Preface

We are delighted that you have chosen a product from LINAK. LINAK systems are high-tech products based on many years of experience in the manufacture and development of actuators, electronic control boxes, controls, and chargers. We are also constantly improving our products to meet customer requirements.

This user manual will tell you how to install, use, and maintain your LINAK LA36 actuator.

We are sure that the LA36 actuator will give you a problem-free operation. Before our products leave the factory they undergo full function and quality testing. Should you nevertheless experience problems with your LINAK products, you are always welcome to contact our service departments or service centres.

Most LINAK subsidiaries have authorised service centres, which are always ready to help you.

LINAK provides a warranty on all its products. This warranty, however, is subject to correct use in accordance with the specifications, maintenance being done correctly and any repairs being carried out at a service centre, which is authorised to repair LINAK products.

LINAK A/S

Safety instructions



Please read the following safety information carefully.

Ensure that all staff who are to connect, mount, or use the actuator are in possession of the necessary information and that they have access to this user manual.

Persons who do not have the necessary experience or knowledge of the product/products must not use the product/products. Besides, persons with reduced physical or mental abilities must not use the product/products, unless they are under surveillance or they have been thoroughly instructed in the use of the apparatus by a person who is responsible for the safety of these persons.

Moreover, children must be under surveillance to ensure that they do not play with the product.

Before you start mounting/dismounting, ensure that the following points are observed:

- The actuator is not in operation.
- The actuator is free from loads that could be released during this work.

Before you put the actuator into operation, check the following:

- The actuator is correctly mounted as indicated in the relevant user instructions.
- The equipment can be freely moved over the actuator's whole working area.
- The actuator is connected to a mains electricity supply/transformer with the correct voltage and which is dimensioned and adapted to the actuator in question.
- Ensure that the voltage applied matches to the voltage specified on the actuator label.
- Ensure that the connection bolts can withstand the wear.
- Ensure that the connection bolts are secured safely.

During operation

- Listen for unusual sounds and watch out for uneven running. Stop the actuator immediately if anything unusual is observed.
- Do not sideload the actuator.
- Use only the actuator within the specified working limits.
- Do not step or kick on the actuator.

When the equipment is not in use

- Switch off the mains supply in order to prevent unintentional operation.
- Check regularly for extraordinary wear.

Classification

The equipment is not suitable for use in the presence of a flammable anaesthetic mixture with air or with oxygen or nitrous oxide.

Important information

Information about the actuators is described under the following two headings:



Warning!

Failing to follow these instructions can cause accidents resulting in serious personal injury.



Recommendation

Failing to follow these instructions can result in the actuator suffering damage or being ruined.



Warnings:

- Do not sideload the actuator.
- Only use the actuator within specified working limits.
- When mounting the LA36 in the application ensure that the bolts can withstand the wear and that they are secured safely.



Recommendations:

- Do not place load on the actuator housing and do prevent impact or blows, or any other form of stress to the housing.
- Ensure that the cable cover is mounted correctly. Use 1.5Nm torque.
- Ensure that the duty cycle and the usage temperatures for LA36 actuators are respected.
- Ensure that the cable cannot be squeezed, pulled or subjected to any other stress.
- Furthermore, it will be good practice to ensure that the actuator is fully retracted in the "normal" position. The reason is that there will be a vacuum inside the actuator if it is extended which over time can lead to water entering the actuator.

DECLARATION OF CONFORMITY

LINAK A/S
Smedevænget 8
DK - 6430 Nordborg

hereby declares that LINAK Actuator Systems composed of:

12 V Battery and Linear Actuator 36xxxxxxxxxx* (* = 1 or A),

complies with the EMC-directive 89/336/EØF according to the standards
EN 61000-6-4:2001 (Electromagnetic compatibility, industry, emission)
EN 61000-6-2:2001 (Electromagnetic compatibility, industry, immunity)
EN 61000-6-3:2001 (Electromagnetic compatibility, residential, commercial
and light-industry, emission)
EN 61000-6-1:2001 (Electromagnetic compatibility, residential, commercial
and light-industry, immunity)

Machinery Directive 98/37/EC Attachment IIB: LINAK A/S prohibit that the actuator system is put into service until the machinery into which the actuator system is to be incorporated has been declared in conformity with the provisions of all relevant directives

Date: 2005-05-13

Signature: 
(Hans Schou Christensen)

DECLARATION OF CONFORMITY

LINAK A/S -
Smedevænget 8
DK - 6430 Nordborg

hereby declares that LINAK Actuator Systems composed of:
24 V Battery and Linear Actuator 36xxxxxxxx*xx (* = 2 or B),

complies with the EMC-directive 89/336/EØF according to the standards
EN 61000-6-4:2001 (Electromagnetic compatibility, industry, emission)
EN 61000-6-2:2001 (Electromagnetic compatibility, industry, immunity)
EN 61000-6-3:2001 (Electromagnetic compatibility, residential, commercial
and light-industry, emission)
EN 61000-6-1:2001 (Electromagnetic compatibility, residential, commercial
and light-industry, immunity)

Machinery Directive 98/37/EC Attachment IIB: LINAK A/S prohibit that the
actuator system is put into service until the machinery into which the actuator
system is to be incorporated has been declared in conformity with the
provisions of all relevant directives

Date: 2005-05-13

Signature:

(Hans Schou Christensen)

DECLARATION OF CONFORMITY

LINAK A/S
Smedevænget 8
DK - 6430 Nordborg

hereby declares that LINAK Actuator Systems composed of:
36 V Battery and Linear Actuator 36xxxxxxxx*xx (* = 3 or C),

complies with the EMC-directive 89/336/EØF according to the standards
EN 61000-6-4:2001 (Electromagnetic compatibility, industry, emission)
EN 61000-6-2:2001 (Electromagnetic compatibility, industry, immunity)
EN 61000-6-3:2001 (Electromagnetic compatibility, residential, commercial
and light-industry, emission)
EN 61000-6-1:2001 (Electromagnetic compatibility, residential, commercial
and light-industry, immunity)

Machinery Directive 98/37/EC Attachment IIB: LINAK A/S prohibit that the
actuator system is put into service until the machinery into which the actuator
system is to be incorporated has been declared in conformity with the
provisions of all relevant directives

Date: 2005-08-24

Signature:

(Hans Schou Christensen)

Misc. on the TECHLINE® actuator system

Warranty

There is an 18 months' warranty on the TECHLINE products against manufacturing faults calculated from the production date of the individual products (see label).

The LINAK warranty is only valid in so far as the equipment has been used and maintained correctly and has not been tampered with. Furthermore, the actuator must not be exposed to violent treatment. In the event of this, the warranty will be ineffective/invalid. For further details, please see LINAK A/S ordinary conditions of sale.

Maintenance

- The actuator must be cleaned at regular intervals to remove dust and dirt and inspected for mechanical damages or wear.
- Inspect attachment points, wires, piston rod, cabinet, and plug, as well as check that the actuator functions correctly.
- The actuator is a closed unit and requires no internal maintenance.
- The actuator is not to be opened by unauthorised personnel. In case the actuator is opened, the warranty will be invalid.
- To ensure that the pregreased inner tube remains lubricated, the actuator must only be washed down when the piston rod is fully retracted.

Maintenance of spherical eyes

In order to maintain a proper performance of the spherical eyes and to increase the resistances against hard environmental wear, we strongly recommend that the spherical (ball bearings) eyes mounted on actuators from LINAK are greased with anticorrosive grease or similar.



Warning!

If irregularities are observed, the actuator must be replaced.

Specifications

Motor:	Permanent magnet motor 12, 24, or 36V *
Motor protection:	Automatic protection resets thermal overload (Option)
Cable:	Motor: 2 x 14 AWG PVC cable Control: 6 x 20 AWG PVC cable **
Gear ratio:	6 different gear ratios available in steel (500 N, 1,700/2,600 N, 4,500 N, and 6,800/10,000 N)
Slip clutch:	Mechanical overload protection through an integrated slip clutch
Brake:	Integrated brake ensures a high self-locking ability. The brake is deactivated when the actuator is powered in order to obtain a high efficiency
Hand crank:	As a standard feature the actuator can be operated manually
Housing:	The housing is made of casted aluminium, coated for outdoor use and in harsh conditions
Spindle part:	Outer tube: Extruded aluminium anodised Inner tube: Stainless steel AISi304/SS2333 Acme spindle: Trapezoidal spindle with high efficiency
Temperature range:	- 30° C to +65° C - 22° F to +150° F Full performance +5° C to +40° C
End play:	2 mm maximum
Weather protection:	Rated IP66 for outdoor use. Furthermore, the actuator can be washed down with a high-pressure cleaner (IP69K)

* Modbus actuators only 24V - please see the

[Modbus installation guide http://www.linak.com/techline/?id3=2363](http://www.linak.com/techline/?id3=2363).

** Special control cables for the Modbus actuator - please see the

[Modbus installation guide http://www.linak.com/techline/?id3=2363](http://www.linak.com/techline/?id3=2363).

Usage

- The duty cycle at max. load is 20% on time. This means if the actuator runs continuously for 20 seconds it must remain off for 80 seconds before operating again.
NB. At 10,000 N only 5%

Mounting guidelines

LINAK® linear actuators are quickly and easily mounted by slipping pins through the holes on each end of the units and into brackets on the machine frame and the load.

The mounting pins must be parallel to each other as shown in Figure 1. Pins, which are not parallel to each other, may cause the actuator to bend and be damaged.

The load should act along the stroke axis of the actuator since off centre loads may cause bending and lead to premature failure. See Figure 2.

Make sure the mounting pins are supported in both ends. Failure to do so could shorten the life of the actuator. Also, avoid applying a skew load on the actuator.

The actuator can rotate around the pivot point in the front and rear end. If this is the case it is of high importance that the actuator is able to move freely over the full stroke length, both during the development and during daily operation. Please pay special attention to the area around the housing where parts can be trapped and cause damages to the application and actuator.

In applications with high dynamic forces LINAK recommends not to use the fully extended or retracted position over longer time, as this can damage the endstop system permanently.

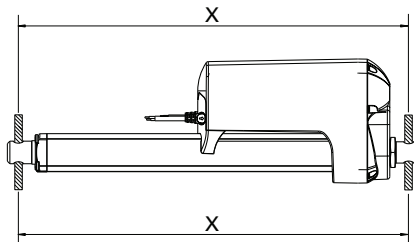

Figure 1

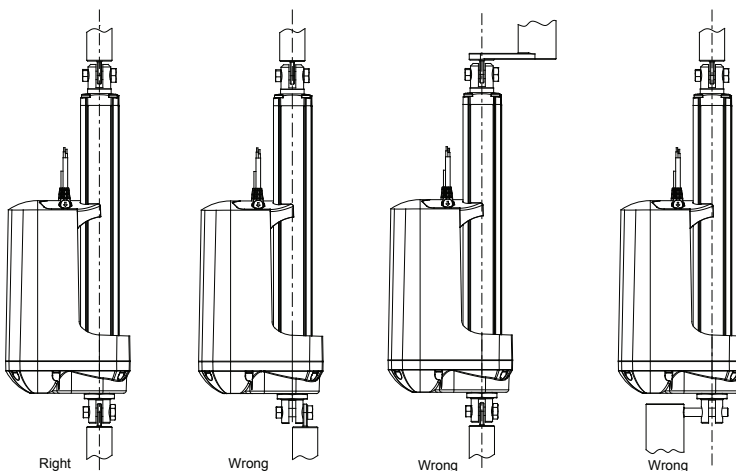

Figure 2

Mounting guidelines



- The mounting pins must have the correct dimension
- The bolts and nuts must be made of a high quality steel grade (e.g. 10.8). No thread on the bolt inside the back fixture or the piston rod eye
- Bolts and nuts must be protected so there is no risk for them to fall out
- Do not use a torque that is too high when mounting the bolts for the back fixture or the piston rod eye. This will stress the fixtures



Please note:

The piston rod eye is only allowed to turn 0-90 degrees.



Instruction concerning the turning of the piston rod eye:

When mounting and taking into use, it is not permitted to make excessive turns of the piston rod eye. In cases where the eye is not positioned correctly, it is permitted to first screw the eye down to its bottom position, at a maximum torque of 2Nm (1), and thereafter a maximum half turn outwards again (2).

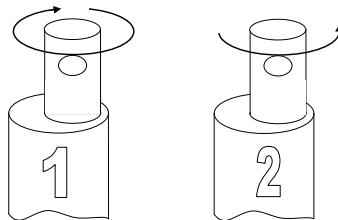

Warning!

If the actuator is used for pull in an application where personal injury can occur, the following is valid:

It is the application manufacturer's responsibility to incorporate a suitable safety arrangement, which will prevent personal injury from occurring, if the actuator should fail



Warning!

LINAK's actuators are not constructed for use within the following fields:

- Offshore installations
- Explosive environments
- Aeroplanes and other aircraft
- Nuclear power generation

Mounting of cables

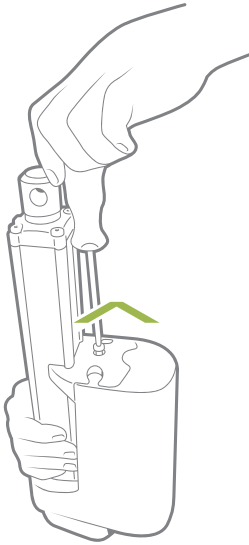

1. Unscrew the cover and remove the two blind plugs.

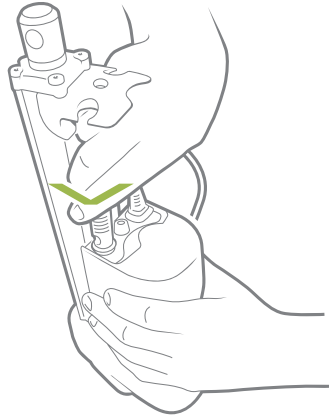

2. Plug in the power cable and/or the signal cable.

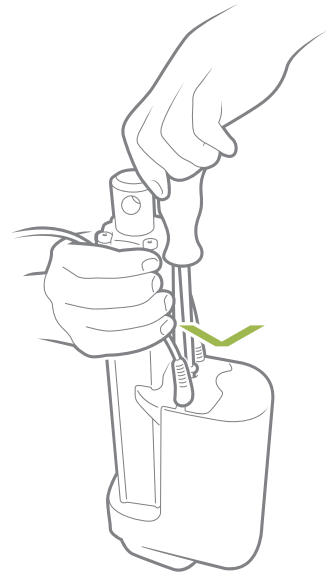

3. Slide the cover onto the actuator.

The torque of the cover screw is approx. 1.5 ± 0.3 Nm

TORX 25IP



When changing the cables on a LINAK actuator, it is important that this is done carefully, in order to protect the plugs and pins. Please be sure that the plug is in the right location and fully pressed in before the cable lid is mounted.

Please note that if the cables are mounted and dismantled more than 3 times the plugs can be damaged. Therefore, we recommend that such cables are discarded and replaced.

We recommend to take some precaution and design the wire connection in a way, where the cable end is kept inside a closed, protected area to guarantee the high IP protection.

Manual hand crank

The manual hand crank can be used in the case of power failure.



6 mm Allen key

The cover over the Allen key socket must be unscrewed before the Allen key can be inserted and the hand crank operated.

Hand Crank Torque: 6 - 8 Nm (2600 N – 6800 N load)

Piston rod movement per turn, app.:

	8 mm	12 mm	20 mm
Gear A	-	11 mm	18 mm
Gear B	-	6 mm	10 mm
Gear C	3 mm	4 mm	7 mm
Gear F	-	-	27 mm



Note: if the actuator is operated as a hand crank, it must be operated by hand, otherwise there is a risk of overloading the actuator and hereby damage the actuator.

- The power supply has to be disconnected during manual operation
- If the actuator is operated as a Hand crank, it must be operated by hand or carefully by machine, otherwise there is a potential risk of overloading and hereby damaging the actuator.
LA36 with CS or Modbus options only by hand
- With stainless steel screws: 5 mm Allen Key

Electrical installation

Actuator without feedback:

Connection diagram:

Fig. 1 : 36xxxxx00xxxxxx & 36xxxxx10xxxxxx

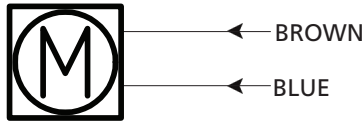

I/O specifications:

Input/Output	Specification	Comments
Description	Permanent magnetic DC motor. See connection diagram, fig. 1 above	
Brown	12, 24 or 36VDC (+/-) 12VDC \pm 20% 24VDC \pm 10% 36VDC \pm 10%	To extend actuator: Connect Brown to positive To retract actuator: Connect Brown to negative
Blue	Under normal conditions: 12V, max. 26A depending on load 24V, max. 13A depending on load 36V, max. 10A depending on load	To extend actuator: Connect Blue to negative To retract actuator: Connect Blue to positive
Red	Not to be connected	
Black	Not to be connected	
Green	Not to be connected	
Yellow	Not to be connected	
Violet	Not to be connected	
White	Not to be connected	

Actuator with endstop signal output:

Connection diagram:

Fig. 2 : 36xxxxx20xxxxxx

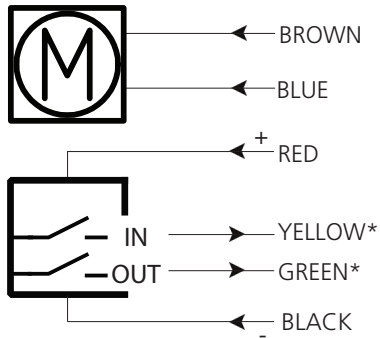

*YELLOW/GREEN:

Endstop signals out are NOT potential free!

If you wish to use the endstop signals, you will have to keep power on the brown, blue, red and black wires, otherwise the signal will be lost.

Actuator with endstop signal output:

I/O specifications:

Input/Output	Specification	Comments
Description	The actuator can be equipped with electronically controlled endstop signals out. See connection diagram, fig. 2 on page 16	
Brown	12, 24 or 36VDC (+/-) 12VDC \pm 20% 24VDC \pm 10% 36VDC \pm 10%	To extend actuator: Connect Brown to positive To retract actuator: Connect Brown to negative
Blue	Under normal conditions: 12V, max. 26A depending on load 24V, max. 13A depending on load 36V, max. 10A depending on load	To extend actuator: Connect Blue to negative To retract actuator: Connect Blue to positive
Red	Signal power supply (+) 12-24VDC	Current consumption: Max. 40mA, also when the actuator is not running
Black	Signal power supply GND (-)	
Green	Endstop signal out	Output voltage min. $V_{IN} - 1V$ Source current max. 100mA NOT potential free
Yellow	Endstop signal in	
Violet	Not to be connected	
White	Not to be connected	

Actuator with relative positioning - Dual Hall:

Connection diagram:

Fig. 3 : 36xxxxx0Hxxxxxx & 36xxxxx1Hxxxxxx

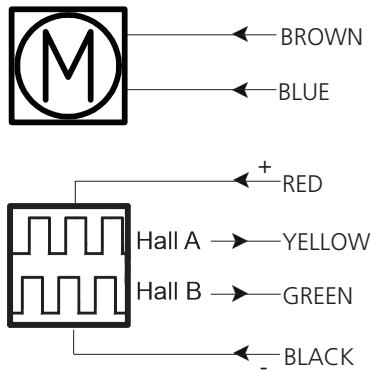

Actuator with relative positioning - Dual Hall:

I/O specifications:

Input/Output	Specification	Comments
Description	<p>The actuator can be equipped with Dual Hall that gives a relative positioning feedback signal when the actuator moves.</p> <p>See connection diagram, fig. 3, page 18</p>	
Brown	<p>12, 24 or 36VDC (+/-)</p> <p>12VDC \pm 20%</p> <p>24VDC \pm 10%</p> <p>36VDC \pm 10%</p>	<p>To extend actuator: Connect Brown to positive</p> <p>To retract actuator: Connect Brown to negative</p>
Blue	<p>Under normal conditions:</p> <p>12V, max. 26A depending on load</p> <p>24V, max. 13A depending on load</p> <p>36V, max. 10A depending on load</p>	<p>To extend actuator: Connect Blue to negative</p> <p>To retract actuator: Connect Blue to positive</p>
Red	<p>Signal power supply (+)</p> <p>12-24VDC</p>	<p>Current consumption: Max. 40mA, also when the actuator is not running</p>
Black	<p>Signal power supply GND (-)</p>	
Green	<p>Hall B</p> <p>Movement per single hall pulse:</p> <p>LA362C Actuator = 0.4 mm per pulse</p> <p>LA363C Actuator = 0.7 mm per pulse</p>	<p>The Hall sensor signals are generated by the turning of the actuator gearing. These signals can be fed into a PLC (Programmable Logic Controller). In the PLC the quadrature signals can be used to register the direction and position of the piston rod.</p> <p>Output voltage:</p> <p>12V : 11V \pm 1V</p> <p>24V : 23V \pm 1V</p> <p>36V : 23V \pm 1V</p> <p>Current output 12mA</p> <p>N.B. For more precise measurements, please contact LINAK A/S.</p>
Yellow	<p>Hall A</p> <p>LA363B Actuator = 1.0 mm per pulse</p> <p>LA363A Actuator = 1.7 mm per pulse</p> <p>LA365A Actuator = 2.9 mm per pulse</p>	
Violet	Not to be connected	
White	Not to be connected	
Diagram of Dual Hall:		

Fig. 3.1

Actuator with endstop signals and relative positioning - Dual Hall:

Connection diagram:

Fig. 4 : 36xxxxx2Hxxxxxx

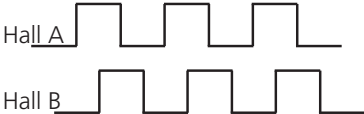
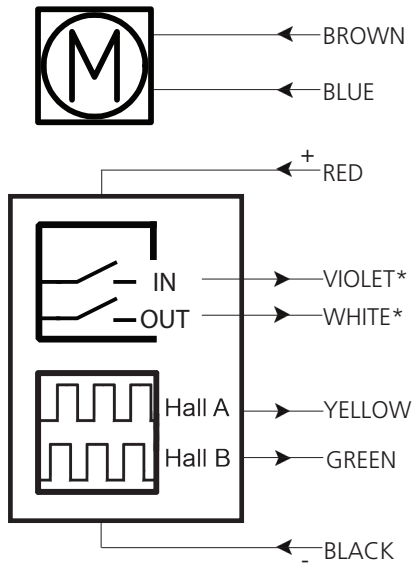

*VIOLET/WHITE:

Endstop signals out are NOT potential free!

If you wish to use the endstop signals, you will have to keep power on the brown, blue, red and black wires, otherwise the signal will be lost.

Actuator with endstop signals and relative positioning - Dual Hall: I/O specifications:

Input/Output	Specification	Comments
Description	<p>The actuator can be equipped with Dual Hall that gives a relative positioning feedback signal when the actuator moves.</p> <p>See connection diagram, fig. 4, page 20</p>	
Brown	<p>12, 24 or 36VDC (+/-)</p> <p>12VDC \pm 20%</p> <p>24VDC \pm 10%</p> <p>36VDC \pm 10%</p>	<p>To extend actuator: Connect Brown to positive</p> <p>To retract actuator: Connect Brown to negative</p>
Blue	<p>Under normal conditions: 12V, max. 26A depending on load 24V, max. 13A depending on load 36V, max. 10A depending on load</p>	<p>To extend actuator: Connect Blue to negative</p> <p>To retract actuator: Connect Blue to positive</p>
Red	<p>Signal power supply (+) 12-24VDC</p>	<p>Current consumption: Max. 40mA, also when the actuator is not running</p>
Black	<p>Signal power supply GND (-)</p>	
Green	<p>Hall B</p> <p>Movement per single hall pulse: LA362C Actuator = 0.4 mm per pulse LA363C Actuator = 0.7 mm per pulse</p>	<p>The Hall sensor signals are generated by the turning of the actuator gearing. These signals can be fed into a PLC (Programmable Logic Controller). In the PLC the quadrature signals can be used to register the direction and position of the piston rod.</p> <p>Output voltage: 12V : 11V \pm 1V 24V : 23V \pm 1V 36V : 23V \pm 1V Current output 12mA</p> <p>N.B. For more precise measurements, please contact LINAK A/S.</p>
Yellow	<p>Hall A</p> <p>LA363B Actuator = 1.0 mm per pulse LA363A Actuator = 1.7 mm per pulse LA365A Actuator = 2.9 mm per pulse</p>	
Violet	<p>Endstop signal in</p>	<p>Output voltage min. $V_{IN} - 1V$ Source current max. 30mA NOT potential free</p>
White	<p>Endstop signal out</p>	
Diagram of Dual Hall:		

Fig. 4.1

Actuator with relative positioning - Single Hall:

Connection diagram:

Fig. 5 : 36xxxxx0Kxxxxxx or 36xxxxx1Kxxxxxx

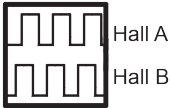
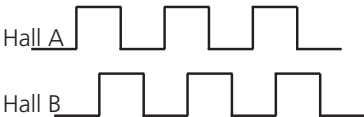
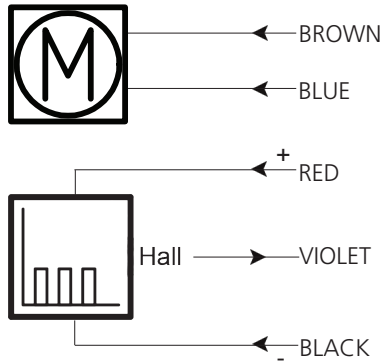

Actuator with relative positioning - Single Hall:

I/O specifications:

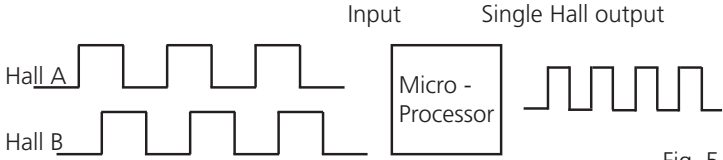
Input/Output	Specification	Comments
Description	<p>The actuator can be equipped with Single Hall that gives a relative positioning feedback signal when the actuator moves.</p> <p>See connection diagram, fig. 5, page 22</p>	
Brown	<p>12, 24 or 36VDC (+/-)</p> <p>12VDC ± 20%</p> <p>24VDC ± 10%</p> <p>36VDC ± 10%</p>	<p>To extend actuator: Connect Brown to positive</p> <p>To retract actuator: Connect Brown to negative</p>
Blue	<p>Under normal conditions: 12V, max. 26A depending on load 24V, max. 13A depending on load 36V, max. 10A depending on load</p>	<p>To extend actuator: Connect Blue to negative</p> <p>To retract actuator: Connect Blue to positive</p>
Red	Signal power supply (+) 12-24VDC	Current consumption: Max. 40mA, also when the actuator is not running
Black	Signal power supply GND (-)	
Green	Not to be connected	
Yellow	Not to be connected	
Violet	<p>Single Hall output (PNP)</p> <p>Movement per Single Hall pulse: LA362C: Actuator = 0.1 mm per count LA363C: Actuator = 0.2 mm per count LA363B: Actuator = 0.3 mm per count LA363A: Actuator = 0.4 mm per count LA365A: Actuator = 0.7 mm per count</p> <p>Frequency: Frequency is 30-125 Hz on Single Hall output depending on load and spindle</p>	<p>Output voltage min. $V_{IN} - 1V$ Max. current output: 12mA Max. 680nF</p> <p>N.B. For more precise measurements, please contact LINAK A/S.</p> <p>Low frequency with a high load. Higher frequency with no load.</p>
	<p>Diagram of Single Hall:</p>  <p style="text-align: right;">Fig. 5.1</p>	
White	Not to be connected	

Actuator with endstop signals and relative positioning - Single Hall:

Connection diagram:

Fig. 6 : 36xxxxx2Kxxxxxx

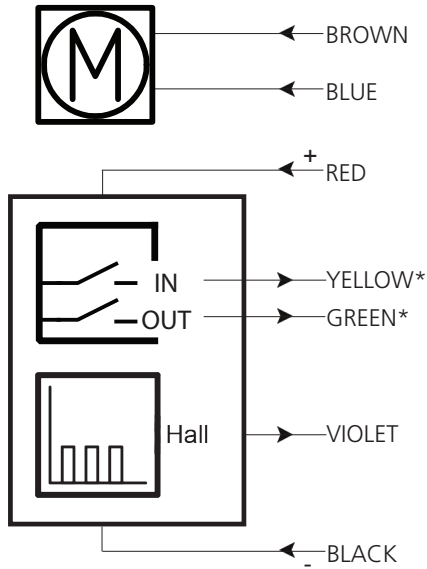

*YELLOW/GREEN:

Endstop signals out are NOT potential free!

If you wish to use the endstop signals, you will have to keep power on the brown, blue, red and black wires, otherwise the signal will be lost.

Actuator with endstop signals and relative positioning - Single Hall: I/O specifications:

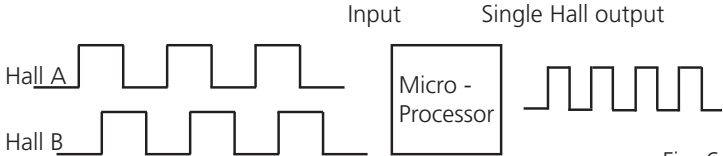
Input/Output	Specification	Comments
Description	<p>The actuator can be equipped with Single Hall that gives a relative positioning feedback signal when the actuator moves.</p> <p>See connection diagram, fig. 6, page 24</p>	
Brown	<p>12, 24 or 36VDC (+/-)</p> <p>12VDC \pm 20%</p> <p>24VDC \pm 10%</p> <p>36VDC \pm 10%</p>	<p>To extend actuator: Connect Brown to positive</p> <p>To retract actuator: Connect Brown to negative</p>
Blue	<p>Under normal conditions:</p> <p>12V, max. 26A depending on load</p> <p>24V, max. 13A depending on load</p> <p>36V, max. 10A depending on load</p>	<p>To extend actuator: Connect Blue to negative</p> <p>To retract actuator: Connect Blue to positive</p>
Red	Signal power supply (+) 12-24VDC	Current consumption: Max. 40mA, also when the actuator is not running
Black	Signal power supply GND (-)	
Green	Endstop signal out	Output voltage min. $V_{IN} - 1V$ Source current max. 100mA NOT potential free
Yellow	Endstop signal in	
Violet	<p>Single Hall output (PNP)</p> <p>Movement per Single Hall pulse: LA362C: Actuator = 0.1 mm per count LA363C: Actuator = 0.2 mm per count LA363B: Actuator = 0.3 mm per count LA363A: Actuator = 0.4 mm per count LA365A: Actuator = 0.7 mm per count</p> <p>Frequency: Frequency is 30-125 Hz on Single Hall output depending on load and spindle</p>	<p>Output voltage min. $V_{IN} - 1V$ Max. current output: 12mA Max. 680nF</p> <p>N.B. For more precise measurements, please contact LINAK A/S.</p> <p>Low frequency with a high load. Higher frequency with no load.</p>
<p>Diagram of Single Hall:</p> 		Fig. 6.1
White	Not to be connected	

Actuator with absolute positioning - Analogue feedback:

Connection diagram:

Fig. 7 : 36xxxxx1Bxxxxxx & 36xxxxx1Cxxxxxx

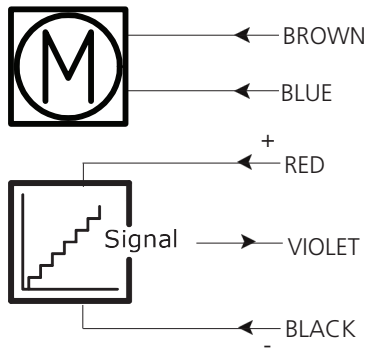

Actuator with absolute positioning - Analogue feedback: I/O specifications:

Input/Output	Specification	Comments
Description	<p>The actuator can be equipped with electronic circuit that gives an analogue feedback signal when the actuator moves.</p> <p>See connection diagram, fig. 7, page 26</p>	
Brown	12, 24 or 36VDC (+/-) 12VDC \pm 20% 24VDC \pm 10% 36VDC \pm 10%	To extend actuator: Connect Brown to positive To retract actuator: Connect Brown to negative
Blue	Under normal conditions: 12V, max. 26A depending on load 24V, max. 13A depending on load 36V, max. 10A depending on load	To extend actuator: Connect Blue to negative To retract actuator: Connect Blue to positive
Red	Signal power supply (+) 12-24VDC	Current consumption: Max. 60mA, also when the actuator is not running
Black	Signal power supply GND (-)	
Green	Not to be connected	
Yellow	Not to be connected	
Violet	Analogue feedback 0-10V (Option B) 0.5-4.5V (Option C)	Tolerances \pm 0.2V Max. current output: 1mA Ripple max. 200mV Transaction delay 100ms Linear feedback 0.5% It is recommendable to have the actuator to activate its limit switches on a regular basis, to ensure more precise positioning
White	Not to be connected	

Actuator with endstop signals and absolute positioning - Analogue feedback:

Connection diagram:

Fig. 8 : 36xxxxx2Bxxxxxx & 36xxxxx2Cxxxxxx

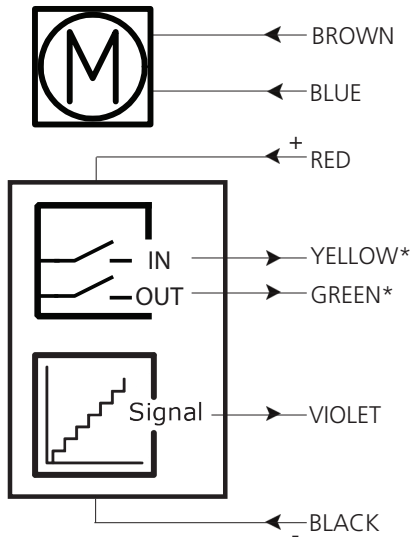

*YELLOW/GREEN:

Endstop signals out are NOT potential free!

If you wish to use the endstop signals, you will have to keep power on the brown, blue, red and black wires, otherwise the signal will be lost.

Actuator with endstop signals and absolute positioning - Analogue feedback:

I/O specifications:

Input/Output	Specification	Comments
Description	<p>The actuator can be equipped with electronic circuit that gives an analogue feedback signal when the actuator moves.</p> <p>See connection diagram, fig. 8, page 28</p>	
Brown	12, 24 or 36VDC (+/-) 12VDC \pm 20% 24VDC \pm 10% 36VDC \pm 10%	To extend actuator: Connect Brown to positive To retract actuator: Connect Brown to negative
Blue	Under normal conditions: 12V, max. 26A depending on load 24V, max. 13A depending on load 36V, max. 10A depending on load	To extend actuator: Connect Blue to negative To retract actuator: Connect Blue to positive
Red	Signal power supply (+) 12-24VDC	Current consumption: Max. 60mA, also when the actuator is not running
Black	Signal power supply GND (-)	
Green	Endstop signal out	Output voltage min. $V_{IN} - 1V$ Source current max. 100mA NOT potential free
Yellow	Endstop signal in	
Violet	Analogue feedback 0-10V (Option B) 0.5-4.5V (Option C)	Tolerances \pm 0.2V Max. current output: 1mA Ripple max. 200mV Transaction delay 20ms Linear feedback 0.5% It is recommendable to have the actuator to activate its limit switches on a regular basis, to ensure more precise positioning
White	Not to be connected	

Actuator with absolute positioning - Mechanical potentiometer feedback:

Connection diagram:

Fig. 9 : 36xxxxx0Pxxxxxx & 36xxxxx1Pxxxxxx

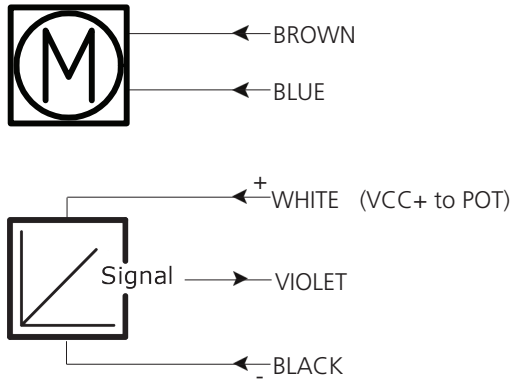

Actuator with absolute positioning - Mechanical potentiometer feedback: I/O specifications:

Input/Output	Specification	Comments
Description	The actuator can be equipped with a mechanical potentiometer, 10 kohm. See connection diagram, fig. 9, page 30	 Bourns 0-10 kohm, 5%, 10-Turn Type: 3540 Wirewound
Brown	12, 24 or 36VDC (+/-) 12VDC \pm 20% 24VDC \pm 10% 36VDC \pm 10%	To extend actuator: Connect Brown to positive To retract actuator: Connect Brown to negative
Blue	Under normal conditions: 12V, max. 26A depending on load 24V, max. 13A depending on load 36V, max. 10A depending on load	To extend actuator: Connect Blue to negative To retract actuator: Connect Blue to positive
Red	Not to be connected	
Black	Signal power supply GND (-)	
Green	Not to be connected	
Yellow	Not to be connected	
Violet	Mechanical potentiometer output Output range with 8mm spindle pitch: 0 kohm = 0mm stroke 10 kohm = 333mm stroke Output range with 12mm spindle pitch: 0 kohm = 0mm stroke 10 kohm = 500mm stroke Output range with 20mm spindle pitch: 0 kohm = 0mm stroke 10 kohm = 833mm stroke	+10V or other value Output protection: 1 kohm protection resistor Linearity: \pm 0.25%
White	VCC+ to POT 10VDC or other values	



Please note that Potentiometer is not possible on variants with fast gear (Spindle pitch 20mm, H Gear).

Actuator with endstop signals and absolute positioning - Mechanical potentiometer feedback:

Connection diagram:

Fig. 10 : 36xxxxx2Pxxxxxx

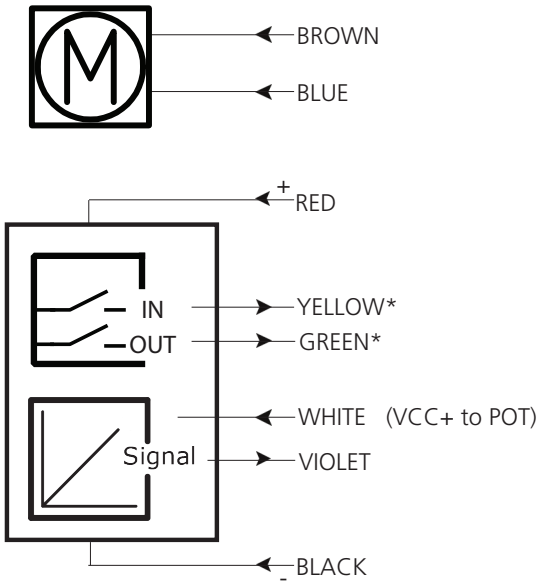

*YELLOW/GREEN:

Endstop signals out are NOT potential free!

If you wish to use the endstop signals, you will have to keep power on the brown, blue, red and black wires, otherwise the signal will be lost.

Actuator with endstop signals and absolute positioning - Mechanical potentiometer feedback:

I/O specifications:

Input/Output	Specification	Comments
Description	The actuator can be equipped with a mechanical potentiometer, 10 kohm. See connection diagram, fig. 10, page 32	 Bourns 0-10 kohm, 5%, 10-Turn Type: 3540 Wirewound
Brown	12, 24 or 36VDC (+/-) 12VDC \pm 20% 24VDC \pm 10% 36VDC \pm 10%	To extend actuator: Connect Brown to positive To retract actuator: Connect Brown to negative
Blue	Under normal conditions: 12V, max. 26A depending on load 24V, max. 13A depending on load 36V, max. 10A depending on load	To extend actuator: Connect Blue to negative To retract actuator: Connect Blue to positive
Red	Signal power supply (+) 12-24VDC	For endstop signals
Black	Signal power supply GND (-)	
Green	Endstop signal out	Output voltage min. $V_{IN} - 1V$ Source current max. 100mA NOT potential free
Yellow	Endstop signal in	
Violet	Mechanical potentiometer output Output range with 8mm spindle pitch: 0 kohm = 0mm stroke 10 kohm = 333mm stroke Output range with 12mm spindle pitch: 0 kohm = 0mm stroke 10 kohm = 500mm stroke Output range with 20mm spindle pitch: 0 kohm = 0mm stroke 10 kohm = 833mm stroke	+10V or other value Output protection: 1 kohm protection resistor Linearity: \pm 0.25%
White	VCC+ to POT 10VDC or other values	



Please note that Potentiometer is not possible on variants with fast gear (Spindle pitch 20mm, H Gear).

Actuator with absolute positioning - PWM:

Connection diagram:

Fig. 11 : 36xxxxx1xxxxxxx

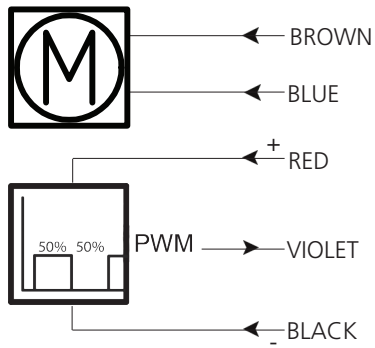

Actuator with absolute positioning - PWM: I/O specifications:

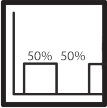
Input/Output	Specification	Comments
Description	<p>The actuator can be equipped with electronic circuit that gives an analogue feedback signal when the actuator moves.</p> <p>See connection diagram, fig. 11, page 34</p>	
Brown	<p>12, 24 or 36VDC (+/-)</p> <p>12VDC \pm 20%</p> <p>24VDC \pm 10%</p> <p>36VDC \pm 10%</p>	<p>To extend actuator: Connect Brown to positive</p> <p>To retract actuator: Connect Brown to negative</p>
Blue	<p>Under normal conditions:</p> <p>12V, max. 26A depending on load</p> <p>24V, max. 13A depending on load</p> <p>36V, max. 10A depending on load</p>	<p>To extend actuator: Connect Blue to negative</p> <p>To retract actuator: Connect Blue to positive</p>
Red	Signal power supply (+) 12-24VDC	Current consumption: Max. 60mA, also when the actuator is not running
Black	Signal power supply GND (-)	
Green	Not to be connected	
Yellow	Not to be connected	
Violet	<p>Digital output feedback (PNP)</p> <p>10-90% (Option 5)</p> <p>20-80% (Option 6)</p>	<p>Output voltage min. $V_{IN} - 1V$</p> <p>Tolerances \pm 2%</p> <p>Max. current output: 12mA</p> <p>Frequency: 75Hz</p> <p>It is recommendable to have the actuator to activate its limit switches on a regular basis, to ensure more precise positioning</p>
White	Not to be connected	

Actuator with endstop signals and absolute positioning - PWM:

Connection diagram:

Fig. 12 : 36xxxxx2xxxxxx

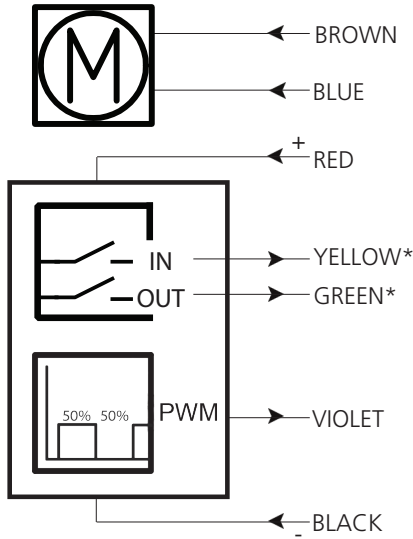

*YELLOW/GREEN:

Endstop signals out are NOT potential free!

If you wish to use the endstop signals, you will have to keep power on the brown, blue, red and black wires, otherwise the signal will be lost.

Actuator with endstop signals and absolute positioning - PWM: I/O specifications:

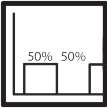
Input/Output	Specification	Comments
Description	<p>The actuator can be equipped with electronic circuit that gives an analogue feedback signal when the actuator moves.</p> <p>See connection diagram, fig. 12, page 36</p>	
Brown	12, 24 or 36VDC (+/-) 12VDC \pm 20% 24VDC \pm 10% 36VDC \pm 10%	<p>To extend actuator: Connect Brown to positive</p> <p>To retract actuator: Connect Brown to negative</p>
Blue	Under normal conditions: 12V, max. 26A depending on load 24V, max. 13A depending on load 36V, max. 10A depending on load	<p>To extend actuator: Connect Blue to negative</p> <p>To retract actuator: Connect Blue to positive</p>
Red	Signal power supply (+) 12-24VDC	Current consumption: Max. 60mA, also when the actuator is not running
Black	Signal power supply GND (-)	
Green	Endstop signal out	Output voltage min. $V_{IN} - 1V$ Source current max. 100mA NOT potential free
Yellow	Endstop signal in	
Violet	Digital output feedback (PNP) 10-90% (Option 5) 20-80% (Option 6)	<p>Output voltage min. $V_{IN} - 1V$ Tolerances \pm 2%</p> <p>Max. current output: 12mA</p> <p>Frequency: 75Hz</p> <p>It is recommendable to have the actuator to activate its limit switches on a regular basis, to ensure more precise positioning</p>
White	Not to be connected	

Actuator with old CS36 (H-bridge) version - Dual Hall:

Connection diagram:

Fig. 13 : 36xxxxx30xxxxxx or 36xxxxx3Hxxxxxx

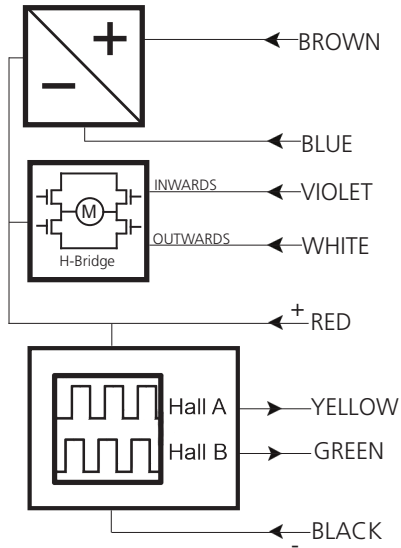

Actuator with old CS36 (H-bridge) version - Dual Hall: I/O specifications:

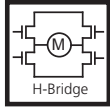
Input/Output	Specification	Comments
Description	The actuator can be equipped with old version of integrated controller. See connection diagram, fig. 13, page 38	
Brown	Only available with 24VDC (+/-) 24VDC ± 10%	To extend actuator: Connect Brown to positive To retract actuator: Connect Brown to negative
Blue	Under normal conditions: 24V, max. 13A depending on load No current cut-off available	To extend actuator: Connect Blue to negative To retract actuator: Connect Blue to positive
Red	Signal power supply (+) 24VDC	Current consumption: Max. 40mA, also when the actuator is not running
Black	Signal power supply GND (-)	
Green	Hall B	Current output for Hall output (PNP) 12mA
Yellow	Hall A	
Violet	Retracts the actuator	On/off voltages: > 67% of V_{IN} = ON < 33% of V_{IN} = OFF Input current: 10mA
White	Extends the actuator	

Actuator with old CS36 (H-bridge) version - Endstop signals:

Connection diagram:

Fig. 14 : 36xxxxx40xxxxxx

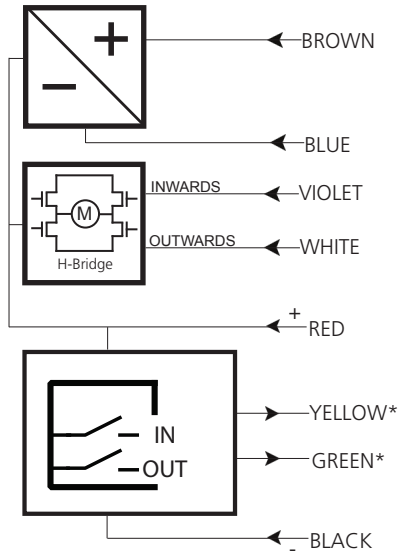

*YELLOW/GREEN:

Endstop signals out are NOT potential free!

If you wish to use the endstop signals, you will have to keep power on the brown, blue, red and black wires, otherwise the signal will be lost.

Actuator with old CS36 (H-bridge) version - Endstop signals: I/O specifications:

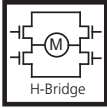
Input/Output	Specification	Comments
Description	The actuator can be equipped with old version of integrated controller. See connection diagram, fig. 14, page 40	 The diagram shows a square H-bridge circuit with a motor symbol (M) in the center. The bridge consists of four transistors (represented by rectangles with diagonal lines) connected to the motor terminals. The text "H-Bridge" is written below the diagram.
Brown	Only available with 24VDC (+/-) 24VDC ± 10%	To extend actuator: Connect Brown to positive To retract actuator: Connect Brown to negative
Blue	Under normal conditions: 24V, max. 13A depending on load No current cut-off available	To extend actuator: Connect Blue to negative To retract actuator: Connect Blue to positive
Red	Signal power supply (+) 24VDC	Current consumption: Max. 40mA, also when the actuator is not running
Black	Signal power supply GND (-)	
Green	Endstop signal out	Output voltage min. $V_{IN} - 1V$ Source current max. 100mA NOT potential free
Yellow	Endstop signal in	
Violet	Retracts the actuator	On/off voltages: > 67% of V_{IN} = ON < 33% of V_{IN} = OFF Input current: 10mA
White	Extends the actuator	

Actuator with IC Basic:

Connection diagram:

Fig. 15 : 36xxxxx+7xxxxxxx

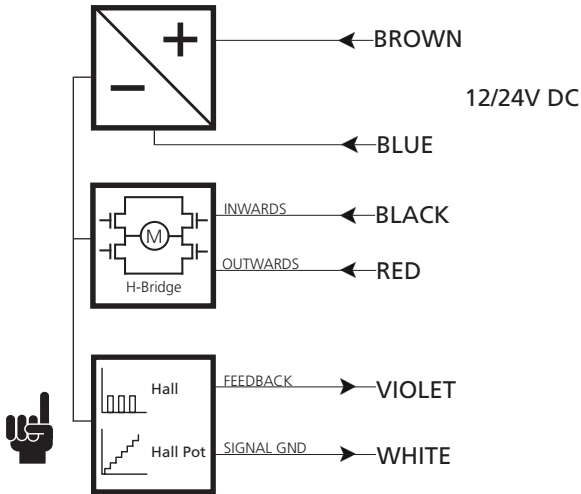

- Please be aware that if the power supply is not properly connected, you might damage the actuator!
- Not programmable with BusLink



It is only possible to order the actuator with one of the two feedback options!

Actuator with IC Basic:

I/O specifications:

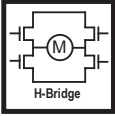
Input/Output	Specification	Comments
Description	<p>Easy to use interface with integrated power electronics (H-bridge). The actuator can also be equipped with electronic circuit that gives an absolute or relative feedback signal.</p> <p>The version with "IC option" cannot be operated with PWM (power supply).</p> <p>See connection diagram, fig. 15, page 42</p>	 <p>The diagram shows a square H-bridge circuit with a motor symbol (M) in the center. The bridge consists of four transistors (represented by lines) connected to the motor terminals. The text "H-Bridge" is written below the diagram.</p>
Brown	<p>12-24VDC + (VCC) Connect Brown to positive</p> <p>12VDC \pm 20% 24VDC \pm 10%</p> <p>Under normal conditions: 12V, max. 26A depending on load 24V, max. 13A depending on load</p>	<p>Note: Do not change the power supply polarity on the brown and blue wires!</p>
Blue	<p>12-24VDC - (GND) Connect Blue to negative</p> <p>12VDC \pm 20% 24VDC \pm 10%</p> <p>Under normal conditions: 12V, max. 26A depending on load 24V, max. 13A depending on load</p>	<p>Power supply GND (-) is electrically connected to the housing</p>
Red	Extends the actuator	On/off voltages:
Black	Retracts the actuator	<p>> 67% of V_{IN} = ON < 33% of V_{IN} = OFF Input current: 10mA</p>
Green	Not to be connected	
Yellow	Not to be connected	

Actuator with IC Basic:

I/O specifications:

Input/Output	Specification	Comments
Violet	Analogue feedback 0-10V (Option 7.2)	Standby power consumption: 12V, 60mA 24V, 45 mA Ripple max. 200mV Transaction delay 20ms Linear feedback 0.5% Max. current output: 1mA It is recommendable to have the actuator to activate its limit switches on a regular basis, to ensure more precise positioning
	Single Hall output (PNP) (Option 7.1)	Output voltage min. $V_{IN} - 1V$ Max. current output: 12mA For more information see fig. 5.1, page 23
White	Signal GND	For correct wiring of power GND and Signal GND see page 48

Actuator with IC Advanced - with BusLink:

Connection diagram:

Fig. 16 : 36xxxxx+8xxxxxx

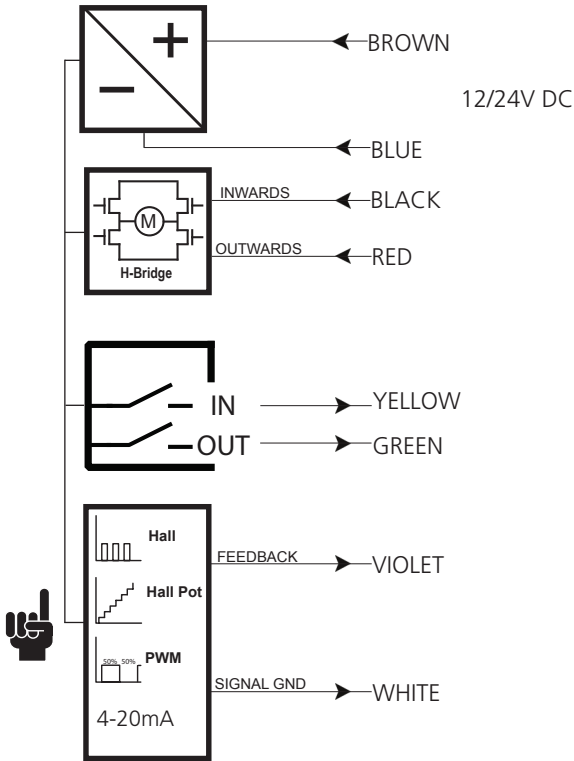

- Configuration of IC Advanced is possible with free BusLink software



It is only possible to configure the actuator with one of the four feedback options at a time!

Please be aware that when choosing single hall, feedback position readout and virtual endstops are not available in BusLink.

Actuator with IC Advanced - with BusLink: I/O specifications:

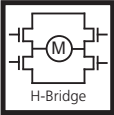
Input/Output	Specification	Comments
Description	<p>Easy to use interface with integrated power electronics (H-bridge). The actuator can also be equipped with electronic circuit that gives an absolute or relative feedback signal. IC Advanced provides a wide range of possibilities for customisation.</p> <p>The version with "IC option" cannot be operated with PWM (power supply).</p> <p>See connection diagram, fig. 16, page 45</p>	
Brown	<p>12-24VDC + (VCC) Connect Brown to positive</p> <p>12VDC \pm 20% 24VDC \pm 10%</p> <p>Under normal conditions: 12V, max. 26A depending on load 24V, max. 13A depending on load</p>	<p>Note: Do not change the power supply polarity on the brown and blue wires!</p>
Blue	<p>12-24VDC - (GND) Connect Blue to negative</p> <p>12VDC \pm 20% 24VDC \pm 10%</p> <p>Under normal conditions: 12V, max. 26A depending on load 24V, max. 13A depending on load</p>	<p>Power supply GND (-) is electrically connected to the housing</p>
Red	<p>Extends the actuator</p>	<p>On/off voltages: > 67% of V_{IN} = ON < 33% of V_{IN} = OFF Input current: 10mA</p>
Black	<p>Retracts the actuator</p>	
Green	<p>Endstop signal out</p>	<p>Output voltage min. V_{IN} - 1V Source current max. 100mA</p> <p>Endstop signals are NOT potential free. Endstop signals can be configured with BusLink software according to any position needed. Only use one virtual endstop - keep one end open for initialisation. (See I/O specifications for endstop on page 17).</p>
Yellow	<p>Endstop signal in</p>	

Actuator with IC Advanced - with BusLink: I/O specifications:

Input/Output	Specification	Comments
Violet	Analogue feedback (Hall Pot): Configure any high/low combination between 0-10V	Ripple max. 200mV Transaction delay 20ms Linear feedback 0.5% Max. current output. 1mA
	Single Hall output (PNP)	Output voltage min. $V_{IN} - 1V$ Max. current output: 12mA For more information, see fig. 6.1, page 25
	Digital output feedback PWM: Configure any high/low combination between 0-100%	Output voltage min. $V_{IN} - 1V$ Frequency: 75Hz \pm 10Hz as standard, but this can be customised. Duty cycle: Any low/high combination between 0 and 100 percent. Open drain source current max. 12mA
	Analogue feedback (4-20mA): Configure any high/low combination between 4-20mA	Transaction delay 20ms Linear feedback 0.5% Output: Source Serial resistance: 12V max. 300 ohm 24V max. 900 ohm
	All absolute value feedbacks (Hall Pot, PWM and 4-20mA)	Standby power consumption: 12V, 60mA 24V, 45mA It is recommendable to have the actuator to activate its limit switches on a regular basis, to ensure more precise positioning
White	Signal GND	For correct wiring of power GND and Signal GND see page 48

BusLink is available for IC Advanced and can be used for:

Diagnostics, manual run and configuration

Download BusLink software here: <http://www.linak.com/techline/?id3=2363>

For more information and easy set-up of BusLink, please follow this link to view the Quick Guide for BusLink: <http://www.linak.com/techline/?id3=2356>

Item numbers for BusLink cables: USB2LIN: USB2LIN05 Adaptor cable: 0964826-A

 Please note that the BusLink cables must be purchased separately from the actuator!

Correct wiring of Power GND and Signal GND for IC Basic and IC Advanced:

When using the feedback output, it is important to use the right connection setup. Attention should be paid to the two ground connections. Power GND in the Power connector and Signal GND in the Control connector. When using either Hall Pot, Hall or PWM feedback, the Signal GND must be used. For optimal accuracy, the Signal GND is connected to the Power GND as close as possible to the feedback input equipment.

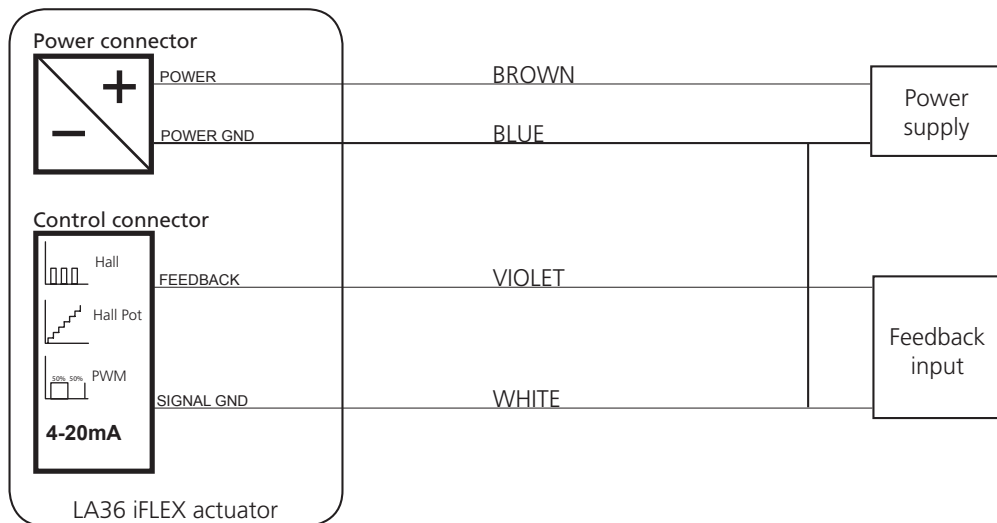

Please note that this section only applies for the following feedback options: Hall Pot, Hall and PWM.

Actuator with Parallel:

Connection diagram:

Fig. 17 : 36xxxxx+9xxxxxx

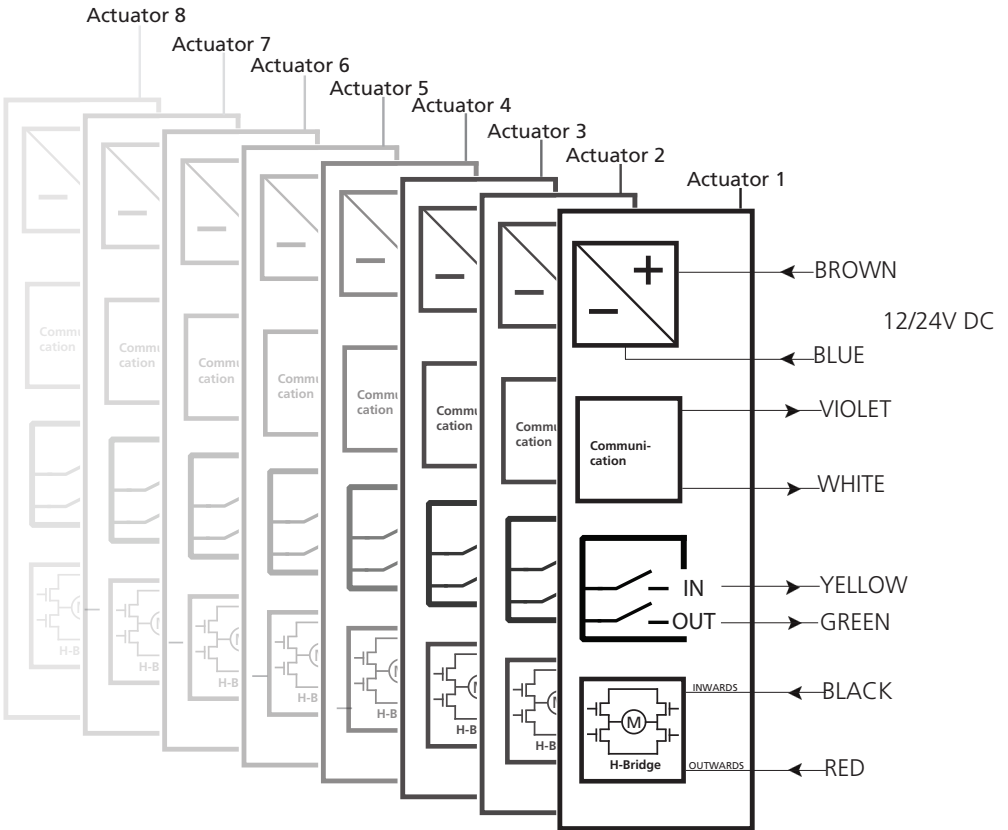

- The green and yellow wires from parallel connected actuators must NOT be interconnected. (See I/O specifications for endstop on page 20).



Only standard power and signal cables are available for parallel.

Actuator with Parallel:
I/O specifications:

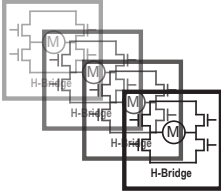
Input/Output	Specification	Comments
Description	<p>Self-configurable option that allows for parallel drive of up to 8 actuators. A master actuator with an integrated H-bridge controller controls up to 7 slaves.</p> <p>The version with "IC option" cannot be operated with PWM (power supply).</p> <p>See connection diagram, fig. 17, page 49</p>	
Brown	<p>12-24VDC + (VCC) Connect Brown to positive</p> <p>12VDC ± 20% 24VDC ± 10%</p> <p>Under normal conditions: 12V, max. 26A depending on load 24V, max. 13A depending on load</p>	<p>Note: Do not change the power supply polarity on the brown and blue wires!</p>
Blue	<p>12-24VDC - (GND) Connect Blue to negative</p> <p>12VDC ± 20% 24VDC ± 10%</p> <p>Under normal conditions: 12V, max. 26A depending on load 24V, max. 13A depending on load</p>	<p>The parallel actuators can run on one OR separate power supplies</p> <p>Power supply GND (-) is electrically connected to the housing</p>
Red	<p>Extends the actuator</p>	<p>On/off voltages: > 67% of V_{IN} = ON < 33% of V_{IN} = OFF</p> <p>Input current: 10mA</p>
Black	<p>Retracts the actuator</p>	<p>It does not matter where the in/ out signals are applied. You can either choose to connect the signal cable to one actuator OR you can choose to connect the signal cable to each actuator on the line. Either way this will ensure parallel drive</p>

**Actuator with Parallel:
I/O specifications:**

Input/Output	Specification	Comments
Green	Endstop signal out	Output voltage min. $V_{IN} - 1V$ Source current max. 100mA NOT potential free
Yellow	Endstop signal in	
Violet	Parallel communication: Violet cords must be connected together	Standby power consumption: 12V, 60mA 24V, 45mA No feedback available during parallel drive
White	Signal GND: White cords must be connected together	For correct wiring of power GND and Signal GND see page 48

The parallel system:

The parallel drive function will support a number of actuators working jointly. The system is self-configurable and when connected, a Master will be dedicated.

The Master will then control up to 7 slaves.

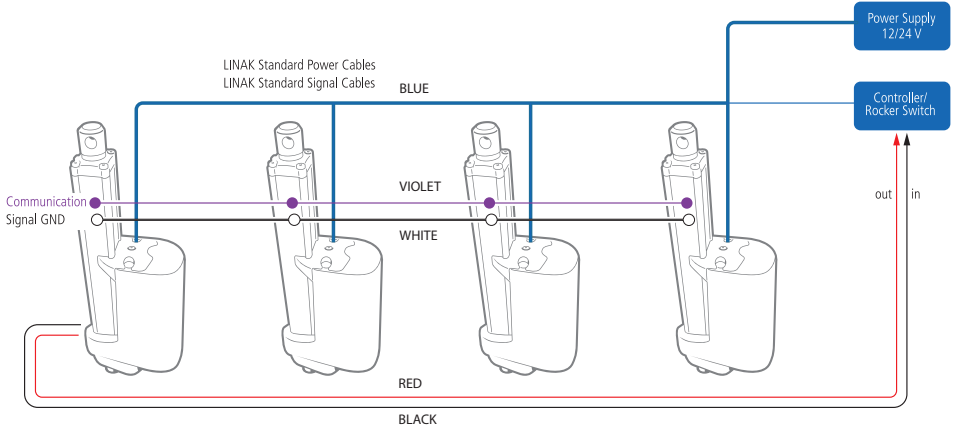

It is both possible to run parallel with a single power supply, or to run each actuator with separate power supplies.

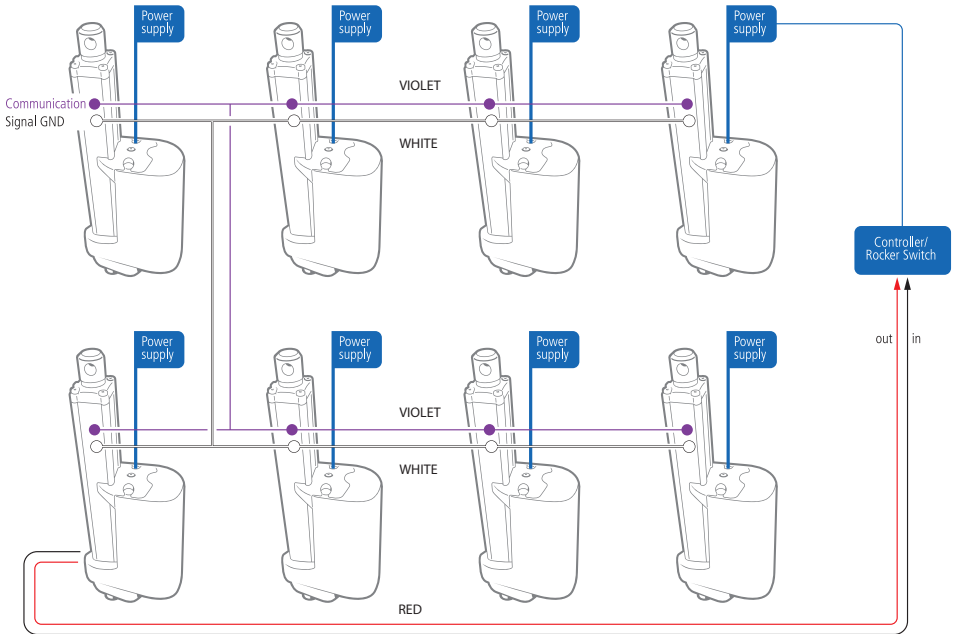

Only standard power and signal cables are available for parallel.

The parallel system:

- The system does not have to run on one power supply only – it can be supplied with several power supplies
- Auto-detection for every single power up if any new actuator is added to the line (system)
- To add or remove actuators from the system, the system needs to be shut down and powered up again. The special software tool is not needed for reconfiguration
- It does not matter where the IN/OUT signal is applied. The signals of all actuators can be connected together
- If an overload occurs, the running of the actuators will be stopped and blocked in that direction, until an activation in the opposite direction has been made or the system has been powered up again
- When all actuators are connected, a Master will be chosen. E.g. with 5 actuators in one system there will be 1 Master and 4 Slaves
- If the Master is removed from the system, a new actuator is automatically chosen as Master



THE SYSTEM WILL NOT DETECT IF AN ACTUATOR IS MISSING AFTER POWERING UP THE SYSTEM AGAIN!

BusLink is available for Parallel

- BusLink can be used for diagnostics
- Parallel can be connected to BusLink – one at a time!
- Service counter is available with Parallel
- Parallel actuator configurations can be changed through BusLink, but all actuators need the same configurations!

Download BusLink software here: <http://www.linak.com/techline/?id3=2363>

For more information and easy set-up of BusLink, please follow this link to view the Quick Guide for BusLink: <http://www.linak.com/techline/?id3=2356>

Item numbers for BusLink cables:

USB2LIN: USB2LIN05

Adaptor cable: 0964826-A



Please note that the BusLink cables must be purchased separately from the actuator!

System Monitoring for Parallel



If one of the actuators have one of the following error conditions, the actuator will immediately STOP:

- H-Bridge fault
- Out of the temperature range (High duty cycle protection)
- Overcurrent (Current cut-off if one or all actuators go in mechanical block)
- SMPS fault
- EOS fault switch
- Hall sensor failure
- Position lost
- Overvoltage (43V DC)

Alignment of the parallel actuator system

If the actuators are not in parallel when starting up, the next movement will run in the following manner:

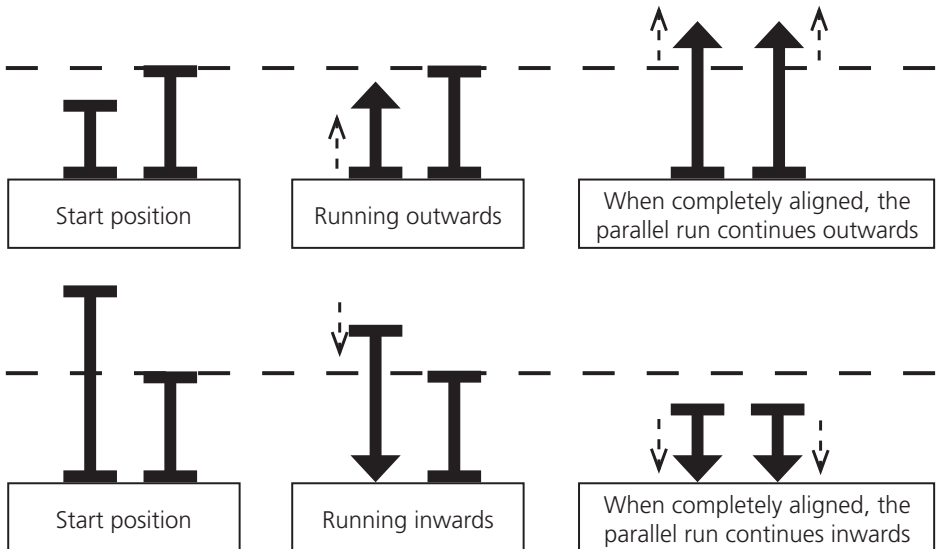

Troubleshooting

Symptom	Possible cause	Action
No motor sound or movement of piston rod	<p>The actuator is not connected to the power supply Cable damaged</p> <p>iFLEX: Wrongly connected + Brown, - Blue Signal required for moving outwards + VCC -> RED Wire Signal required for moving inwards + VCC -> Black Wire</p>	<ul style="list-style-type: none"> • Connect actuator to the power supply • Change cable • Please contact LINAK
Excessive electricity Consumption	Misalignment or overload in application	<ul style="list-style-type: none"> • Align or reduce load • Try to run the actuator without load • Please contact LINAK
Motor runs but spindle does not move	Gearwheel or spindle damaged	<ul style="list-style-type: none"> • Please contact LINAK
Actuator cannot lift full load	<p>Clutch is worn Motor is damaged</p> <p>iFLEX: Current cut off (overload in application)</p>	<ul style="list-style-type: none"> • Please contact LINAK <p>iFLEX (for IC advanced and Parallel only): Connect actuator to BusLink and check the current parameters (inwards/outwards)</p>
No signal from Feedback	<p>Cable damaged Bad connection Potentiometer damaged Hall sensor or magnet damaged Wrongly Connected Violet: Signal out White: Signal GND</p> <p>iFLEX: Check Feedback option - connect to BusLink</p>	<ul style="list-style-type: none"> • Change cable • Check wiring <p>iFLEX: Connect actuator to BusLink and check current parameters. Initialise the actuator in both directions</p>

Troubleshooting

Symptom	Possible cause	Action
<p>Motor runs too slowly or does not run with full force</p> <p>Motor runs in smaller steps</p>	<p>Load is higher than specified</p> <p>Voltage drop in cable (Use of long cables can negatively affect the performance of the actuator)</p> <p>iFLEX: Current Cut-off</p>	<ul style="list-style-type: none"> • Check power supply • Reduce load <p>iFLEX: Connect actuator to BusLink and check current parameters (reason for last stop)</p>
<p>Actuator(s) cannot hold the chosen load</p>	<p>Load is higher than specified</p>	<ul style="list-style-type: none"> • Reduce load
<p>For iFLEX Parallel</p> <p>Only one or X actuators is in movement</p>	<p>Wrongly connected: + Brown, - Blue</p> <p>Violet: Parallel communication Violet cords must be connected together</p> <p>White: GND Signal Ground White cords must be connected together</p>	<ul style="list-style-type: none"> • Check wiring for communication and power supply • Put power on all actuators at the same time
<p>For iFLEX Parallel Only</p> <p>Short movements before stops</p>	<p>Cable damaged Actuator NOT connected properly. Violet: Parallel communication White: GND Signal Ground</p>	<ul style="list-style-type: none"> • Connect actuators via BusLink one at the time and check monitoring for each actuator (reason for last stop)
<p>For iFLEX Parallel Only</p> <p>Actuator(s) cannot lift full load</p>	<p>Overload in application</p> <p>Actuator stops because of current cut-off</p>	<ul style="list-style-type: none"> • Reduce load • Connect actuators via BusLink one at the time and check monitoring for each actuator



Be aware of Modbus actuator - please see the [Modbus installation guide](http://www.linak.com/techline/?id3=2363).

<http://www.linak.com/techline/?id3=2363>

ACTUATOR DIMENSIONS

TECHLINE® LA36:

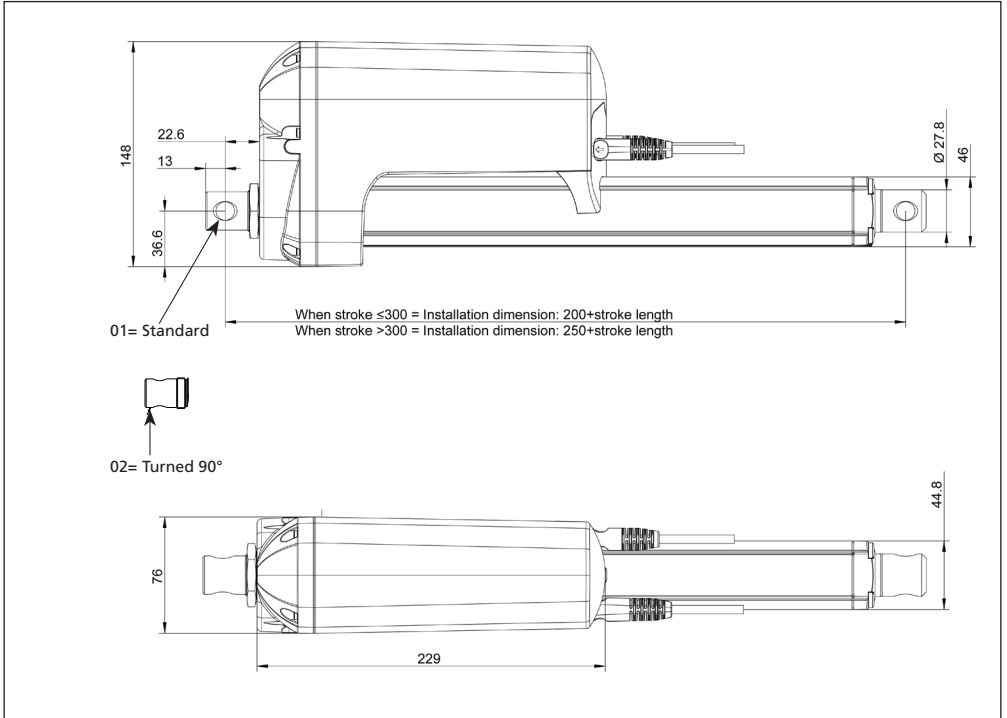

Built-in dimensions

	Piston rod		"0" / from the surface		"1" / to the centre of the hole		"2" / to the centre of the hole		"3" / from the surface	
Back fixture	Stroke <=300 Stroke > 300		Stroke <=300 Stroke > 300		Stroke <=300 Stroke > 300		Stroke <=300 Stroke > 300		Stroke <=300 Stroke > 300	
"0" / from the surface	189	239	194	244	194	244	181	231		
"1" and "2" / to the centre of the hole	195	245	200	250	200	250	187	237		
"3" and "4" / to the centre of the hole	195	245	200	250	200	250	187	237		
"5" / from the surface	180	230	185	235	185	235	173	223		
"6" / from the surface	180	230	185	235	185	235	173	223		
"7" and "8" / to the centre of the hole	195	245	200	250	200	250	187	237		
"A" and "B" / to the centre of the hole	195	245	200	250	200	250	187	237		
"C" and "D" / to the centre of the hole	195	245	200	250	200	250	187	237		

	Piston rod		"4" / from the surface		"5" / to the centre of the hole		"C" / to the centre of the hole		"D" / to the centre of the hole	
Back fixture	Stroke <=300 Stroke > 300		Stroke <=300 Stroke > 300		Stroke <=300 Stroke > 300		Stroke <=300 Stroke > 300		Stroke <=300 Stroke > 300	
"0" / from the surface	181	231	194	244	209	259	209	259		
"1" and "2" / to the centre of the hole	187	237	200	250	215	265	215	265		
"3" and "4" / to the centre of the hole	187	237	200	250	215	265	215	265		
"5" / from the surface	172	222	185	235	200	250	200	250		
"6" / from the surface	172 [*]	222 [*]	185	235	200	250	200	250		
"7" and "8" / to the centre of the hole	187	237	200	250	215	265	215	265		
"A" and "B" / to the centre of the hole	187	237	200	250	215	265	215	265		
"C" and "D" / to the centre of the hole	187	237	200	250	215	265	215	265		

* These built-in dimensions are measured according to the illustration below.

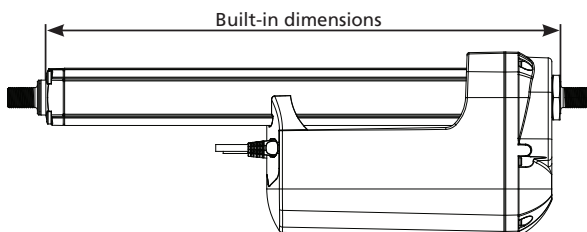

Speed and current curves

The values below are typical values and made with a stable power supply and an ambient temperature of 20°C.

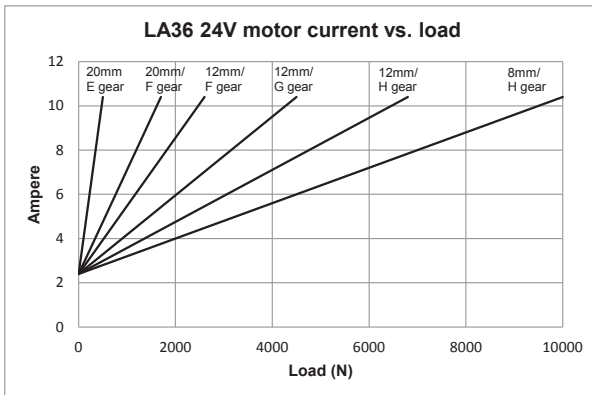
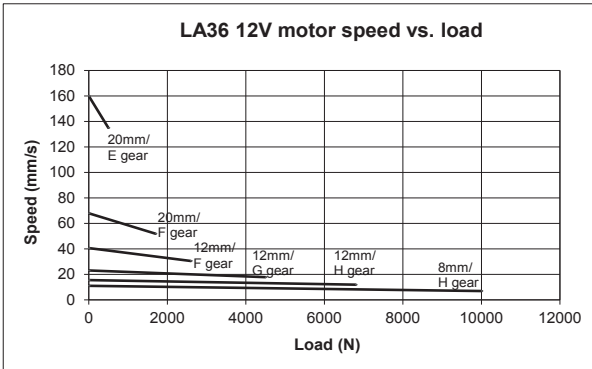
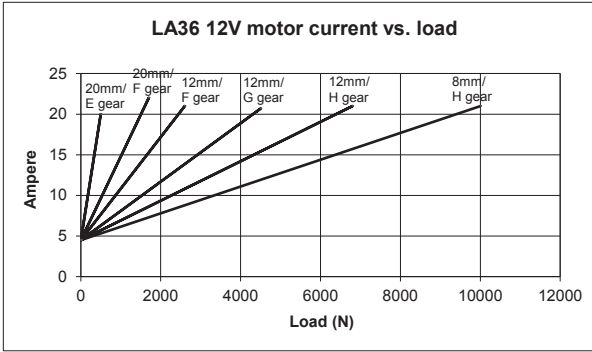

All measurements above describe the spindle pitch (e.g. 20mm) and the gear type (e.g. E gear) of the actuator.

Speed and current are based on a nominal power supply of 12, 24, 36VDC.

Speed and current curves

The values below are typical values and made with a stable power supply and an ambient temperature of 20°C.

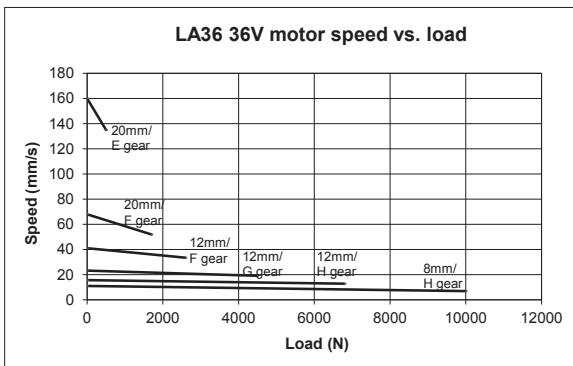
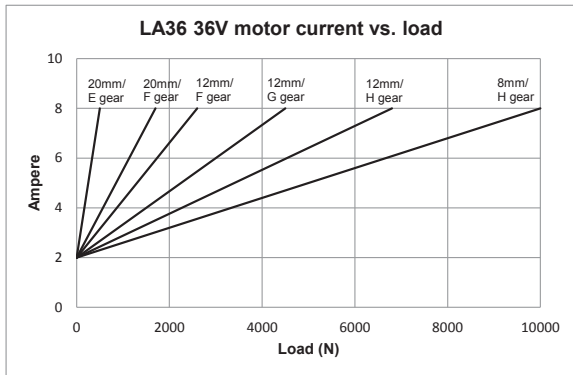
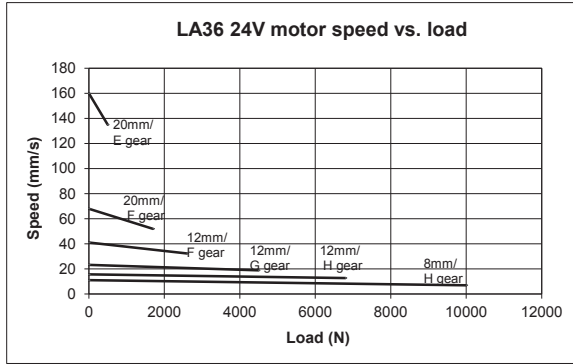

All measurements above describe the spindle pitch (e.g. 20mm) and the gear type (e.g. E gear) of the actuator.

Speed and current are based on a nominal power supply of 12, 24, 36VDC.

Repair and spare parts

Repair

Only an authorised LINAK® service centre should repair LINAK actuator systems. Systems to be repaired under warranty must be sent to an authorised LINAK service centre.

In order to avoid the risk of malfunction, all actuator repairs must only be carried out by an authorised LINAK Service shop or repairer, as special tools and parts must be used.

If a system is opened by unauthorised personnel there is a risk that it may malfunction at a later date.

Spare parts

LINAK can supply spindle parts and motor parts as spare parts. Please indicate the designation from the label when ordering spare parts from your nearest authorised LINAK dealer.

Main groups of disposal

LINAK's products may be disposed of, possibly by dividing them into different waste groups for recycling or combustion.

Product	Metal scrap	Cable scrap	Electronic scrap	Plastic recycling or combustion
LA36	X	X	X	X

We recommend that our product is disassembled as much as possible at the disposal and that you try to recycle it.

Label for LA36

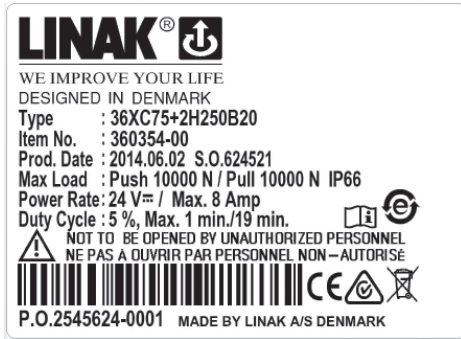

- 1. Type.: 36XC75+2H250B20**
Describes the basic functionality of the product.
- 2. Item no.: 360354-00**
Sales and ordering code
- 3. Prod. Date.: YYYY.MM.DD S.O. 624521**
Production date describes when the product has been produced. This date is the reference for warranty claims. Sales order references are printed on the invoice

4. Max Load.: Push 10000N / Pull 10000N IP66

Describes the maximum load that the product can be exposed to in compression and tension. This line also contains a reference to the product's IP protection degree

5. Power Rate.: 24VDC / Max. 8 Amp

Input voltage for the product and maximum current consumption

6. Duty Cycle.: Max 5%







The duty cycle defines the maximum period during operation without interruption. After operation, a pause must be observed. It is important that the operator follows the instructions of the duty cycle; otherwise, a possible overload may result in reduced product life/errors

7. P.O 2545624-0001

The LINAK production order followed by a unique sequential identification number

Key to symbols

The following symbols are used on the LA36 label.

Symbol	Norms	Approvals
	WEEE Directive 2002/96/EC	Wheelie bin
	Compliance to all relevant EC directives	CE
	C-Tick 2002: The Australian EMC	C-Tick
	China Pollution control mark (also indicates recyclability)	China RoHS legislation
	ISO 7000- 0434A: Caution	
	Operating instructions	

LINAK APPLICATION POLICY

The purpose of the application policy is to define areas of responsibilities in relation to applying a LINAK product defined as hardware, software, technical advice, etc. related to an existing or new customer application.

LINAK products as defined above are applicable for a wide range of applications within the Medical, Furniture, Desk, and Industry areas. Yet, LINAK cannot know all the conditions under which LINAK products will be installed, used, and operated, as each individual application is unique.

The suitability and functionality of the LINAK product and its performance under varying conditions (application, vibration, load, humidity, temperature, frequency, etc.) can only be verified by testing, and shall ultimately be the responsibility of the LINAK customer using any LINAK product.

LINAK shall be responsible solely that the LINAK products comply with the specifications set out by LINAK and it shall be the responsibility of the LINAK customer to ensure that the specific LINAK product can be used for the application in question.