

DIN-32895-Ø8x31x11,5mm Chain(KG831A)

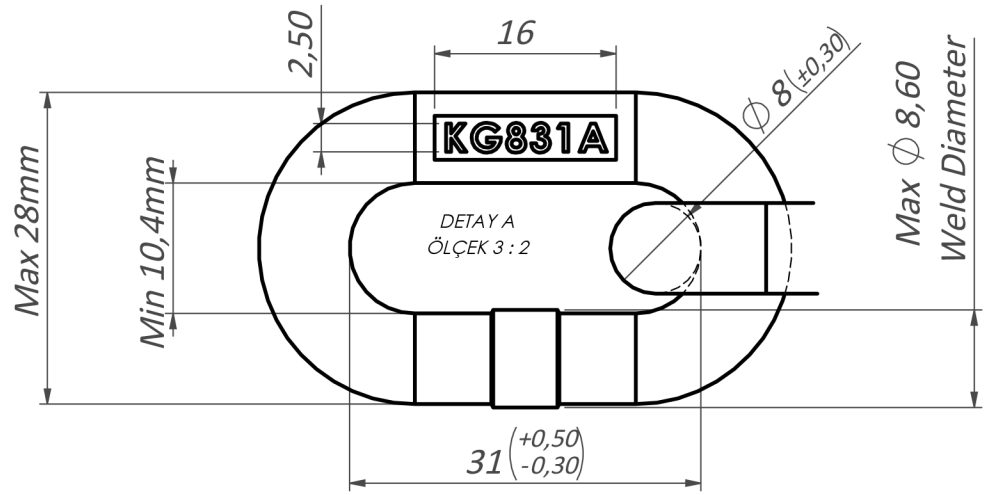
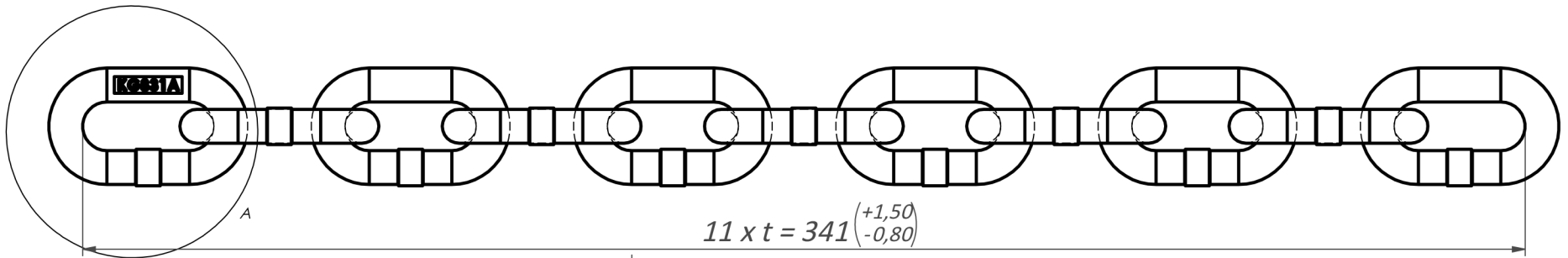

Properties & Notes		Tolerances for Total Meters in Production	
Material	Alloy Steel		
Standards for manufacturing and testing	DIN -32895	1,023mt - 33link	Min : 1023mm Max : 1026mm
Breaking Force (BF)	Min 71 kN	4,991mt - 161link	Min : 4991mm Max : 5006mm
Manufacturing Proof Force (MPF)	45 kN	10,013mt - 323link	Min : 10013mm Max : 10043mm
Working Load Limit (WLL)	Max 17 kN	24,983mt - 806-808link	Min : 24986mm Max : 25061mm
Ultimate Elongation (A)	% 10 min	50,003mt - 1613-1617link	Min : 50003mm Max : 50153mm
Bend Deflection (f)	7 mm Min	100,006mt - 3226-3235link	Min : 100006mm Max : 100306mm

NOTE : Unless otherwise stated, the tolerances in the table apply. However, for double chain strips, the maximum difference between them should not exceed 0.1%.