

Technical
Information

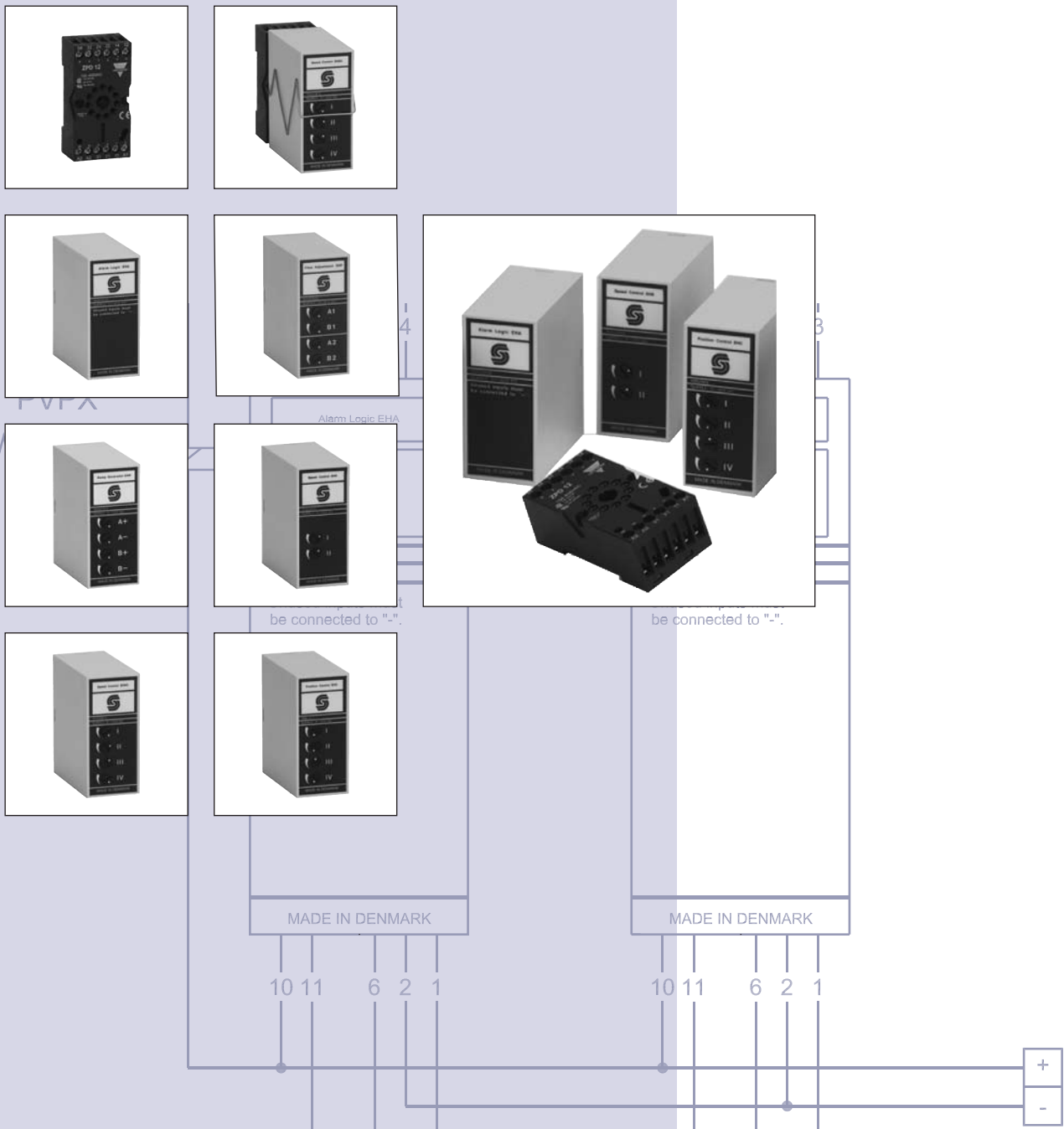

Revision History

Table of Revisions

| Date | Page | Changed | Rev |
|----------|------|----------------|-----|
| Oct 2004 | All | First edition | A |
| May 2010 | 48 | Japan location | AB |

Electronic Control Modules - EH Modules

Electronic control modules - EH modules 3
 General 3

Mounting Base and Accessories, EHB

General 4
 Dimensions, code numbers and weight 6

Electronic Flow Regulation EHF

General 5
 Function 5
 Signal monitoring 5
 Characteristic 6
 Electrical system 6
 Technical data 7
 Code numbers and weight 7

Electronic Alarm Logic EHA

General 8
 Function 8
 Electrical system 10
 Monitoring more than eight functions 11
 Extra safety 12
 Changeover between electrical remote operation and mechanical operation 15
 Technical data 13
 Code number and weight 13

Electronic Ramp Generator EHR

General 14
 Function 14
 Signal monitoring 14
 Electrical system principle 1 15
 Electrical system principle 2 16
 Ramp times 17
 External break contacts 17
 KA, KB signals 18
 Technical data 18
 Code number and weights 19

© 2010 Sauer-Danfoss. All rights reserved.

Sauer-Danfoss accepts no responsibility for possible errors in catalogs, brochures and other printed material. Sauer-Danfoss reserves the right to alter its products without prior notice. This also applies to products already ordered provided that such alterations can be made without affecting agreed specifications. All trademarks in this material are properties of their respective owners. Sauer-Danfoss, the Sauer-Danfoss logotype, the Sauer-Danfoss S-icon, PLUS+1™, What really matters is inside® and Know-How in Motion™ are trademarks of the Sauer-Danfoss Group.

Front cover illustrations: F301 115, F301 116, F301 117, F301 118, F301 119, F301 120, F301 121, F301 122, F301 124
 Drawing: 155L101fa

| | | |
|--|--|-----------------|
| Electronic Speed Control EHS | General | 20 |
| | Function..... | 20 |
| | Potentiometers | 20 |
| | Potentiometer I - adjustment | 20 |
| | Potentiometer II - adjustment | 21 |
| | Potentiometer (P) | 21 |
| | Recommendation | 21 |
| | Input reference..... | 22 |
| Electronic Speed Control EHS (continued) | Electrical connection..... | 22 |
| | Technical data..... | 23 |
| | Code number and weight | 23 |
| Electronic, Frequency Controlled Closed Loop Speed Control EHSC | General | 24 |
| | Adjustment possibilities..... | 24 |
| | Function monitoring..... | 25 |
| | Adjustments | 25 |
| | Potentiometer (P) | 28 |
| | Resistance (R) | 28 |
| | Electrical system | 29 |
| | Required control and feedback frequency signal | 30 |
| | Main spools and electrical actuation modules..... | 30 |
| Code number and weight | 30 | |
| Electronic, Voltage Controlled Loop Speed Control EHSC | General | 31 |
| | Adjustment possibilities | 31 |
| | Function monitoring..... | 32 |
| | Adjustments | 32 |
| | Potentiometer (P) | 34 |
| | Resistance (R) | 35 |
| | Electrical system | 35 |
| | Technical data..... | 36 |
| | Required feedback frequency signal..... | 36 |
| | Main spools and electrical actuation modules..... | 36 |
| | Code numbers and weight | 36 |
| Electronic Closed Loop Position Control EHC | General | 37 |
| | Adjustment possibilities | 37 |
| | Inverse function | 38 |
| | Interruption of the signal output | 38 |
| | ON/OFF signal t1/t6..... | 39 |
| | Redundant position transducer | 39 |
| | Function monitoring..... | 39 |
| | Adjustment..... | 40 |
| | electrical system | 41 |
| | Electrical system | 42 |
| | Code numbers and weight | 42 |
| | Dimensions | Dimensions..... |



F301 115

General

Sauer-Danfoss electronic control modules are a series of module boxes used for signal matching, for the control of the electric activating modules of a proportional valve, and for function monitoring in hydraulic systems. EH modules are built into a plastic box with an 11-pole plug and are designed in compliance with IEC publication 67, second edition part 1, drawing 67-1-18a.

General

Mounting base EHB, 11-pole, for EH modules.

EHB can be mounted using two screws. It can also be clipped onto DIN rails (DIN 46277).

EHB is designed to be wired and contains self-lifting terminals and cross/slotted screws.

ON all electrical diagrams with EH modules the terminal connections are located in relation to EHB. If another mounting base is used, the terminal connections can be re-allocated, but the terminal numbers will remain the same.

Retaining clip in spring steel for additionally securing EH modules on EHB where strong vibrations occur. The code number covers 10 off retaining clips.



F301 116



F301 117

**Dimension
 Code Numbers and
 Weight**

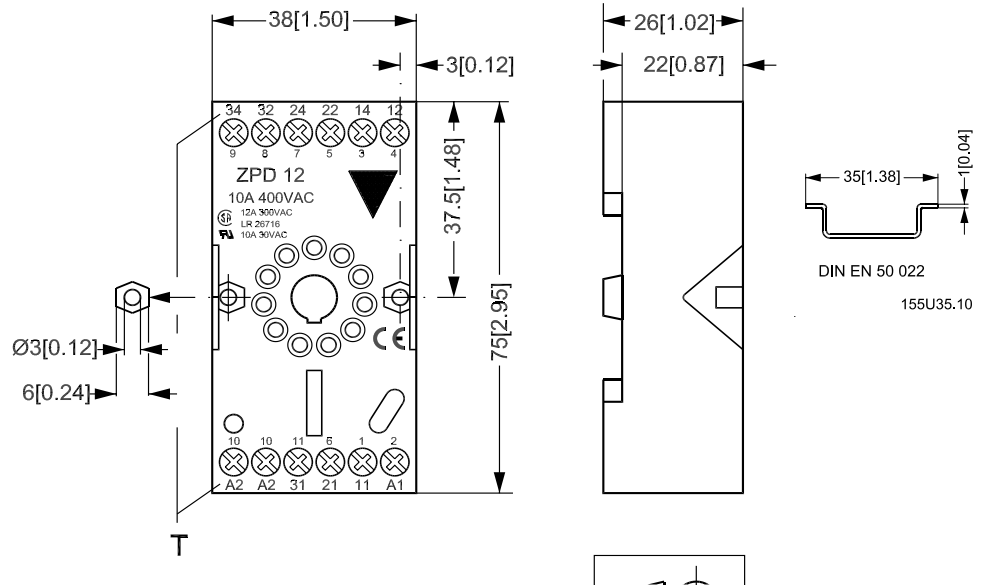

Mounting base

| Type | EHB |
|-----------------|---------------|
| Code no. | 155U0933 |
| Weight, kg [lb] | 0.065 [0.143] |

Retaining clip

| | |
|-----------|----------|
| Code no.* | 155U0932 |
|-----------|----------|

*10 pcs. retaining clips

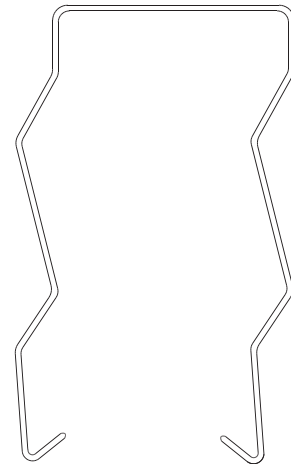

155U140.10

General

Sauer-Danfoss electronic flow regulation EHF is for use where the requirement is individual reduction of the flow from the two ports of the proportional valve.

The flow can be reduced individually for ports A and B, infinitely down to 25% of maximum flow.

An EHF built into an electrohydraulic system gives very precise control of the working functions.

EHF is supplied for the regulation of two working functions.



F301118

Function

EHF must be inserted in the signal connection between the electric remote control lever and PVG proportional valve.

There are two built-in potentiometers per function. Independently of each other, these will limit the signal voltage and thereby the flow from ports A and B.

The remote control unit retains its full regulation range because EHF incorporates dead-band compensation and reduced signal voltage instead of mechanical reduction of the regulation range of the remote control unit.

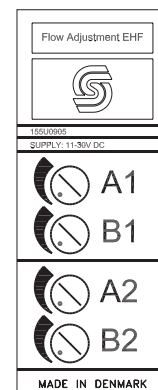

155U157.10

Signal Monitoring

EHF has signal monitoring on the signal inputs (terminals 3 and 4). This means that input signals must lie within the range $0.15 \cdot U_{DC}$ to $0.85 \cdot U_{DC}$.

If the signal is outside the stated range, e.g. as a consequence of short-circuiting to plus or minus supply, the signal monitoring cuts off the output signal to the proportional valve which then immediately sets the main spool into neutral position.

If monitoring has cut off the output signal, EHF can only begin functioning again when the supply voltage has been cut off.

Characteristic

Flow as a function of the input signal and the two potentiometers for the flow limitation at ports A and B.

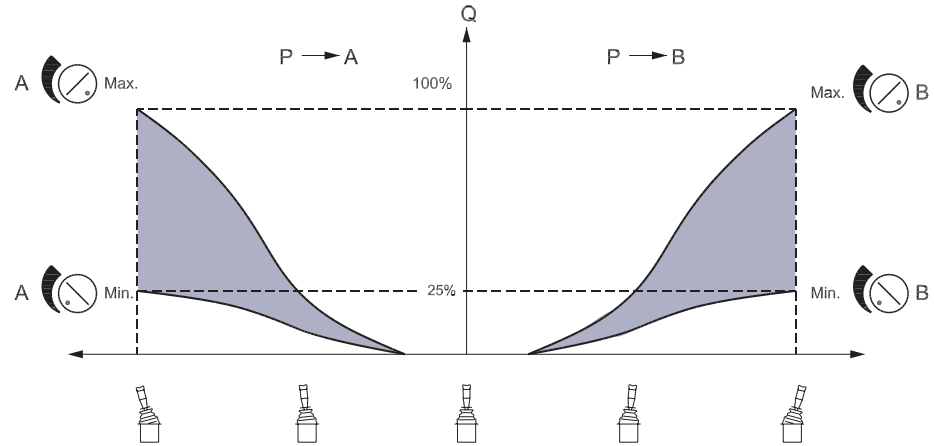

155U41.10

Electrical System

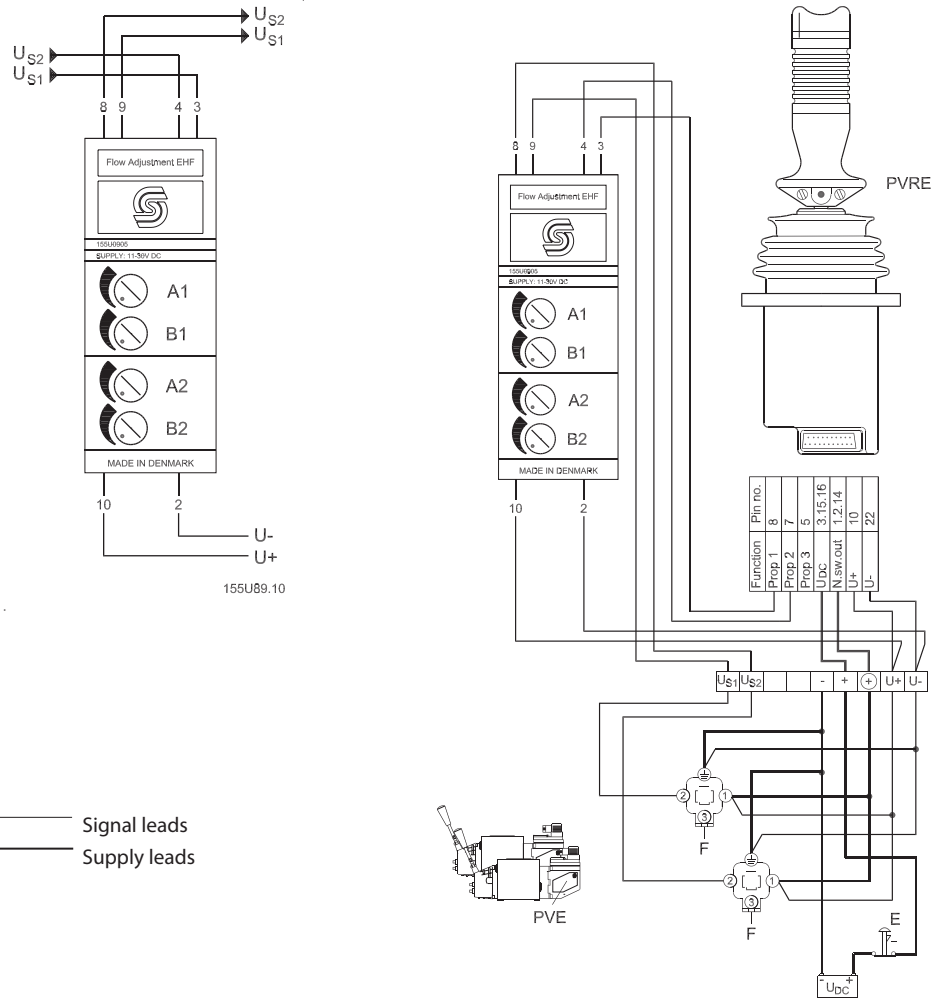

155U77.10

Technical Data

| | | |
|---------------------------|---|--|
| Supply voltage | U_{DC} | 11 - 30 V |
| | Max. ripple | 5% |
| Current consumption | | < 50 mA |
| Output voltage (U_s) | $\frac{U_s}{U_{DC}}$ | 0.25 → 0.75 |
| Neutral voltage (U_s) | $\frac{U_s}{U_{DC}}$ | 0.5 |
| Input signal | | Remote control lever, potentiometer |
| Input impedance | | 12 k Ω at $0.5 \cdot U_{DC}$ |
| Output signal | Max. load | Two parallelconnected PVEs |
| | Min. load impedance to $0.5 \cdot U_{DC}$ | 6 k Ω |
| Signal current max. | $U_{DC} = 12\text{ V}$ | $\pm 0.5\text{ mA}$ |
| | $U_{DC} = 24\text{ V}$ | $\pm 1.0\text{ mA}$ |
| Ambient temperature | | -30 to +60°C [-22 to 140 °F] |
| Enclosure to IEC 529 | | IP 42 |

EHF must be connected to the supply voltage at the same point as the remote control lever.

Code Numbers and Weight

| Type | Code number | Weight | |
|------|-------------|--------|--------|
| | | kg | [lb] |
| EHF | 155U0905 | 0.10 | [0.22] |

General

Sauer-Danfoss EHA electronic alarm logic modules are used primarily where together with PVEH electric activation modules they must meet requirements for optimum system safety. In principle, EHA can be compared with eight series-connected relays that collect alarm signals from up to eight PVEH activation modules and via the series connection combine them into a single active output signal.

The output signal is able to control electric PVPX and PVPE relief valves, normally open (NO) version which will relieve the LS signal/pump pressure to tank on fault signal from PVEH. These relief functions make the PVG valves hydraulically inactive. Alternatively, EHA can be used to control sirens, warning lamps and other alarm sources to indicate function fault.



F301119

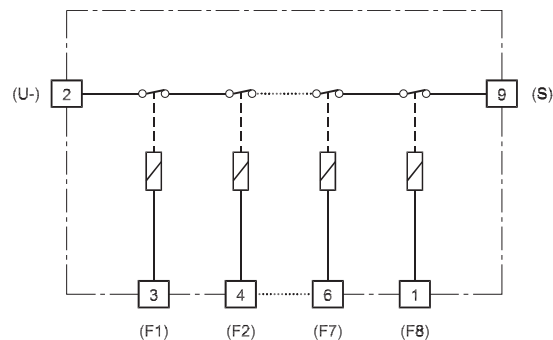

155U150.10

Function

The alarm outputs from the electrically activated PVEHs in a valve group must be connected to EHA.

EHA is built up so that it is able to monitor up to eight PVEH alarm outputs.

With fault-free function, the EHA output signal is internally connected to minus

Fault-free function

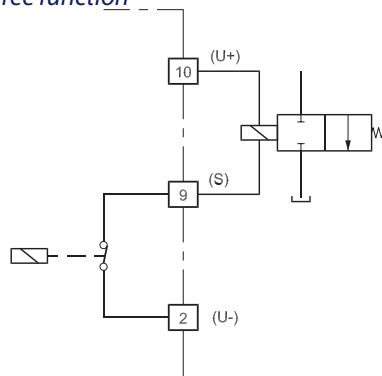

Fault function

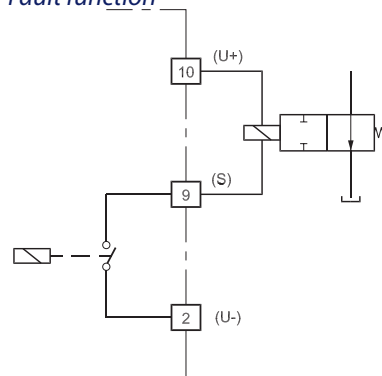

155U148.10

**Function
 (continued)**

If one or more of the PVEH alarms indicate a fault, the EHA output signal is cut off immediately.

To ensure correct function, all unused inputs must be connected to minus, i.e. EHA regards all inputs without connection as a fault. In addition, all input signals exceeding 8 V are also regarded as faults while signals of less than 3 V are regarded as fault-free.

In the range 3-8 V the condition remains undefined.

EHA automatically resets when the fault condition no longer exists.

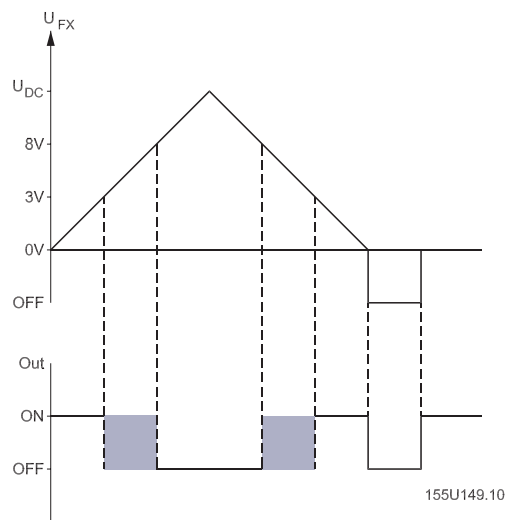

Electrical System

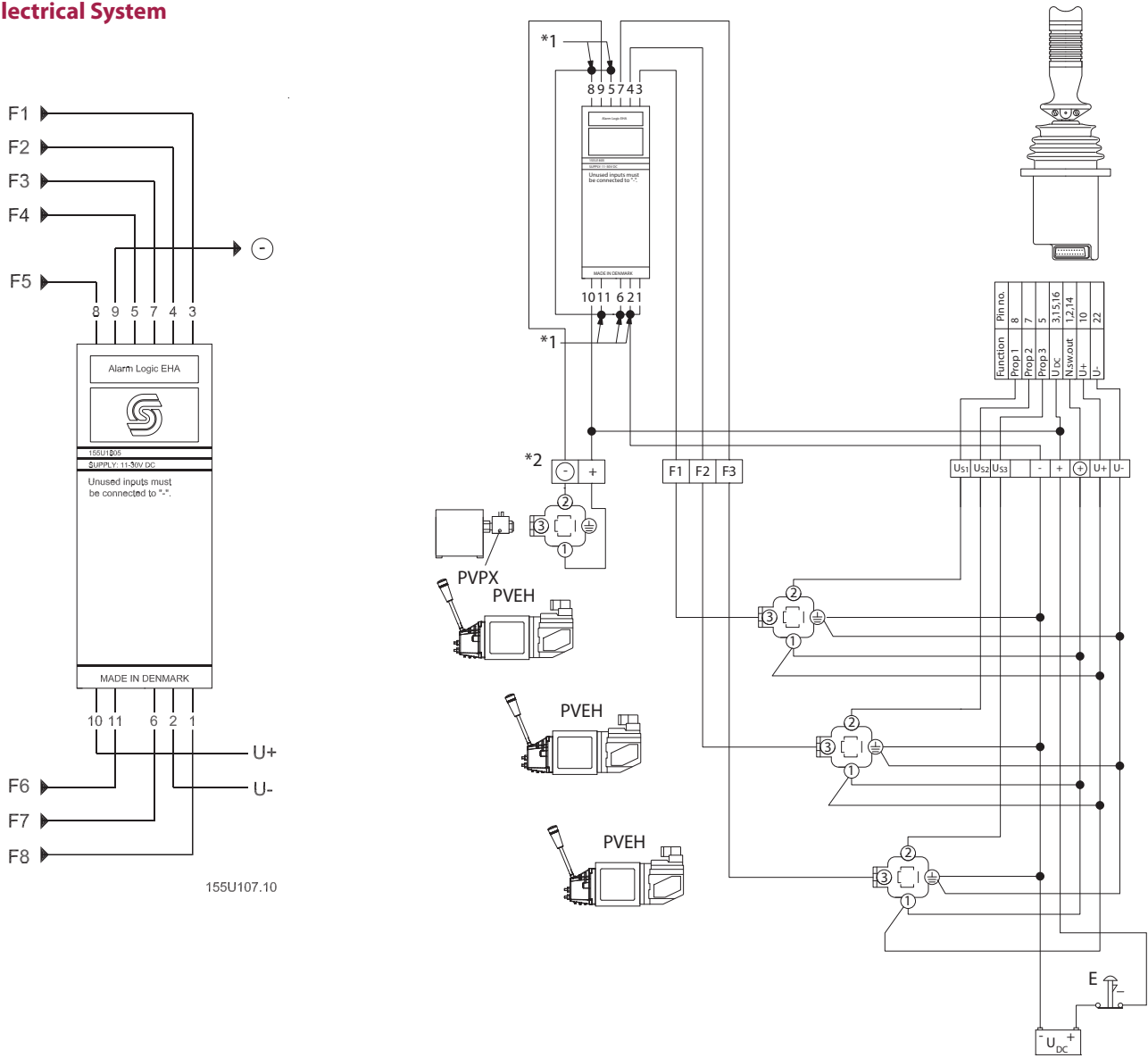

155U107.10

V310176.A

- 1: To avoid being regarded as a fault, unused inputs must be connected to minus.
- E: Emergency stop

**Monitoring more than
 Eight Functions**

With standard connections, EHA will monitor up to eight alarm outputs. If more outputs are to be monitored, two or more EHAs can be connected in series by allowing the output from one EHA to control an input on the following EHA. This extends the capacity by seven inputs for every extra EHA.

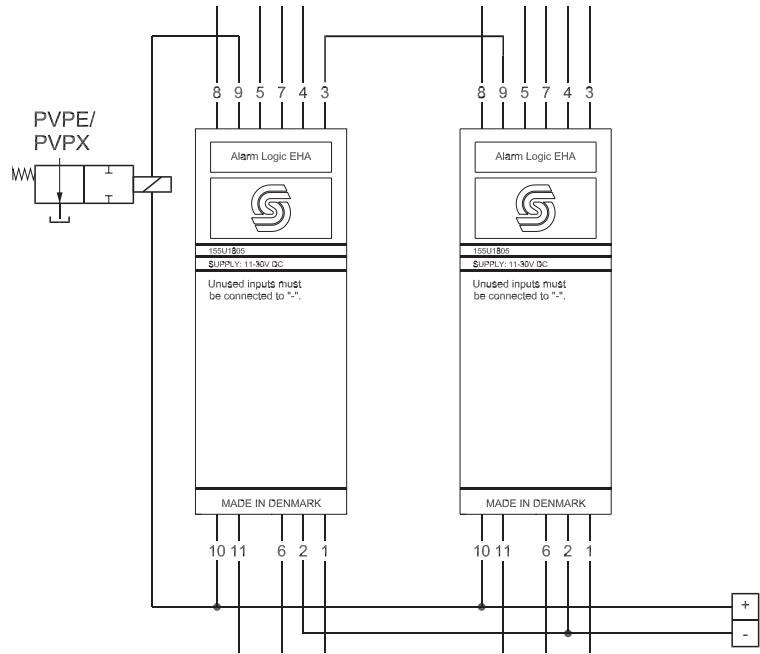

155U101.10

**Changeover between
 Electric Remote
 Operation and
 Mechanical Operation**

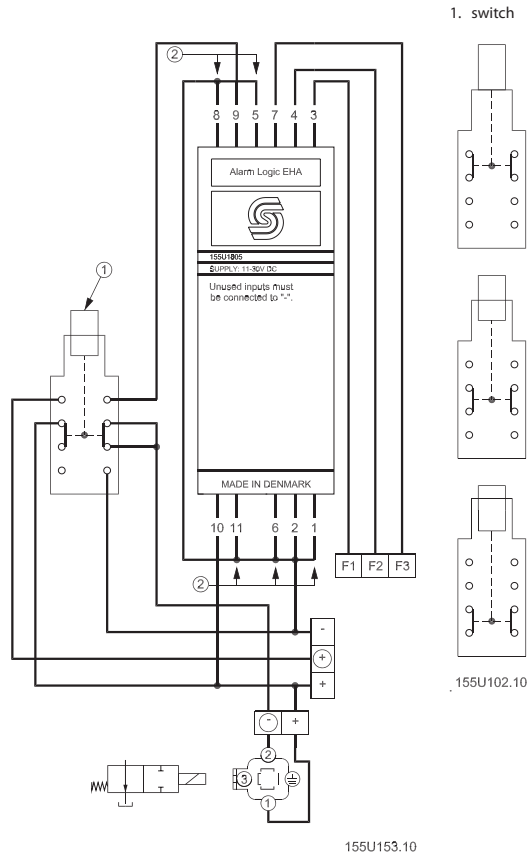

1. switch

Position 1 : Electrical system operation
 The hydraulics can only be operated by electrical remote control. The PVE's lock main spools hydraulically and prevent mechanical operation.

Position 2 : Off
 The hydraulics cannot be operated either mechanically or electrically.

Position 3 : Mechanical system operation
 The hydraulics can only be operated mechanically. The relief valve is activated only via the switch.

155U102.10

2. unused inputs must be connected to minus

Technical Data

| | | |
|---|-------------------|------------------------------------|
| Supply voltage | U_{DC} | 11 - 30 V |
| | Max. ripple | 5% |
| Current consumption without output load | | < 40 mA |
| Input signal | | Tapping from PVEH fault monitoring |
| | Fault-free signal | 0 - 3 V |
| | Fault signal | 8 V - U_{DC} /Off |
| Input impedance | | >3 k Ω |
| Output load | | 30 V / 1.5 A |
| Ambient temperature | | -30 to + 60°C [-22 to 140 °F] |
| Enclosure to IEC 529 | | IP 42 |

EHA must be connected to supply voltage at the same point as PVEH.

**Code Number and
 Weight**

| Type | Code number | Weight | |
|------|-------------|--------|--------|
| | | kg | [lb] |
| EHA | 155U1805 | 0.09 | [0.20] |

General

Sauer-Danfoss electronic ramp generator EHR controls the acceleration and deceleration times for flow from proportional valve ports A and B.

The acceleration and deceleration control is individual for Ports A and B. This form of control is called ramping of, positive and negative respectively. As standard, ramp times can be controlled from 0-2.5 s, but can be extended up to 20 s.

When used in an electrohydraulic system, EHR gives "soft" start and stop of the working function.



F301120

Function

EHR is inserted in the signal connection between the electric remote control lever and the activation module in the proportional valve.

EHR damps rapid signal changes while signals that are changed more slowly than the set ramp times are not changed.

EHR contains four potentiometers for the setting of ramp times. The setting of positive ramps, are made with A+ and B+ potentiometers for A and B ports respectively, while negative ramps, are set with A- and B- potentiometers.

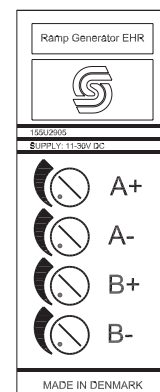

155U162.10

There are two different ways of building in EHR:

- Principle I : Positive and negative ramps
- Principle II : Primarily positive ramps.

These two principles are described in more detail in the section on the electrical system.

Signal Monitoring

EHR incorporates signal input monitoring, terminal 3. This means that the input signal must lie within the limits $0.15 \cdot U_{DC}$ to $0.85 \cdot U_{DC}$. If these limits are exceeded, e.g. as a consequence of short-circuiting to plus or minus supply voltage, the signal monitoring cuts off the output signal to the proportional valve which as a result immediately neutral positions the main spool.

If the signal monitoring has cut off the output signal, EHR will only function again after the voltage supply to it has been cut off.

**Electrical System
 Principle 1**

With the following system it is possible to obtain positive/negative ramps for all input signal changes.

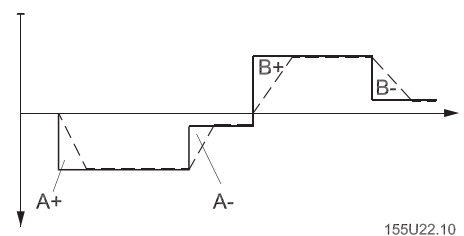
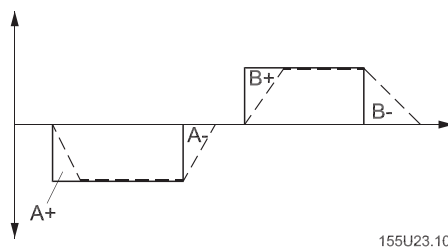
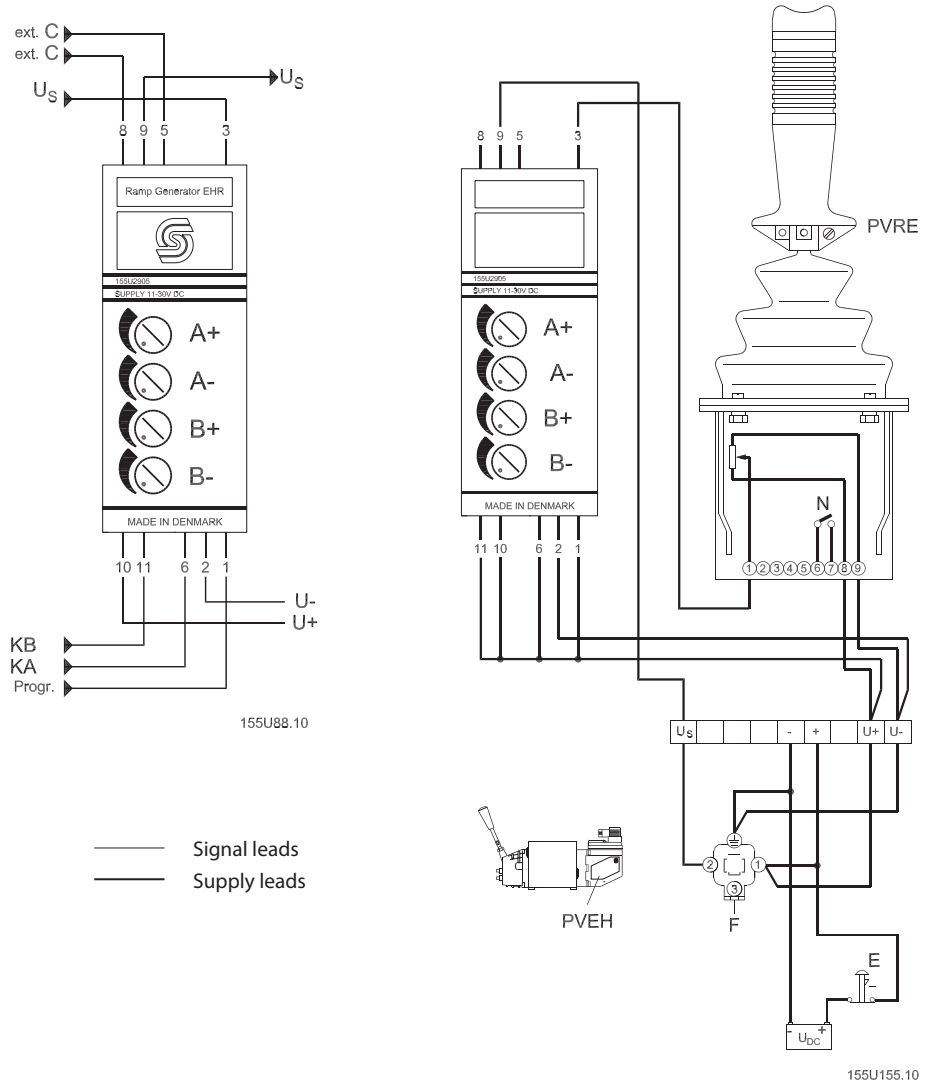

A signal change over neutral means that the negative ramp is complete before the positive ramp begins.

Terminals 1 and 10 are short-circuited. The neutral position switch (N) is not used. If the external break contacts (see page 18) are not used, terminals 6 and 11 must be short-circuited to terminal 10.

**Electrical System
 Principle 2**

The following system will give mainly positive ramps.

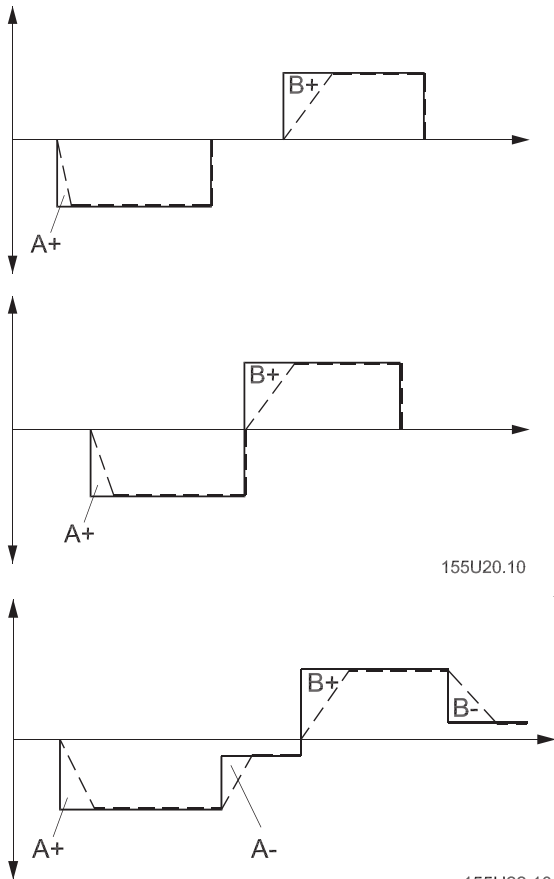
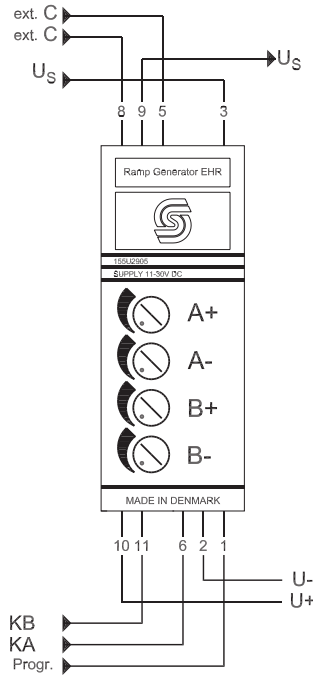

155U20.10

155U22.10

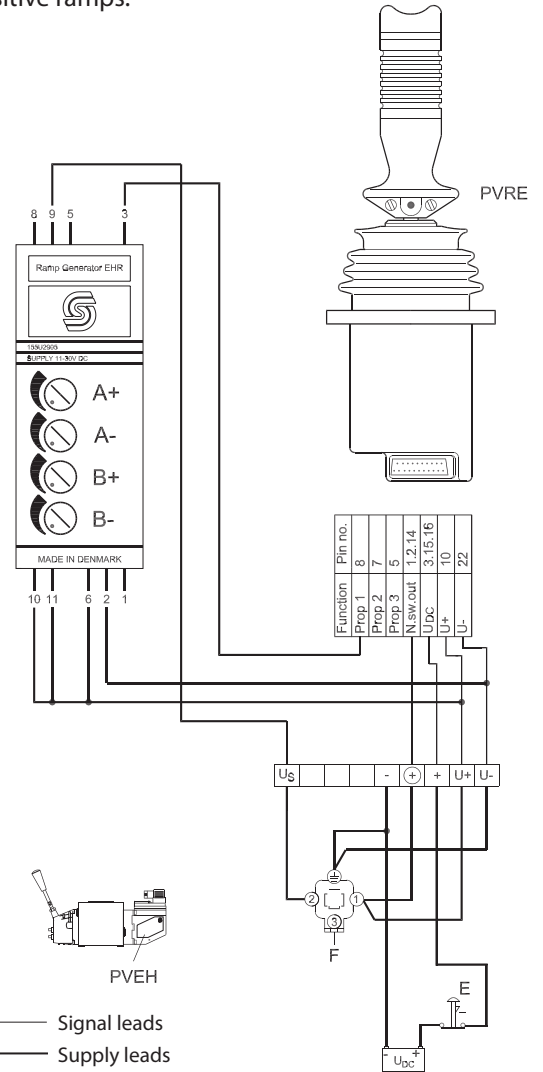

155U156.11

An input signal that goes to or passes neutral will prevent a negative ramp. Negative ramps can be obtained in two ways:

- 1) On signal changes that do not go completely to neutral.
- 2) With use of external break contacts (see page 18).

To fulfil principle II, terminal 1 and 10 must not be short-circuited. If the external break contacts are not used, terminals 6 and 11 must be short-circuited to terminal 10.

Ramp Times

As standard, ramp times can be set between 0 and 2.5 s for 0 to max. flow. Ramp times can be increased by inserting a bipolar capacitor externally between terminals 8 and 5.

Ramp times are dependent on the size of the capacitor, which can be calculated using the following formula for $t > 2.5$ s:

$$C = \frac{t-2.5}{0.7} \quad [\mu F]$$

t is the required ramp time in seconds. The ramp time must not exceed 20 seconds.

To ensure that the capacitor (C) functions as intended, it must have very low leakage current (see specification in technical data).

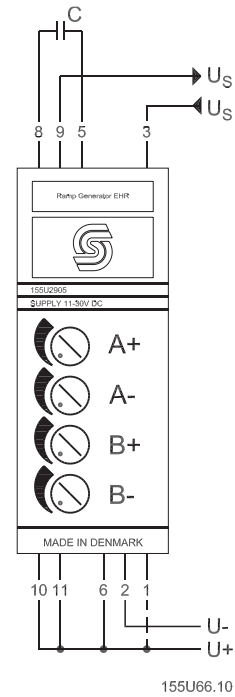

155U66.10

External Break Contacts

Negative ramps can be obtained with break contacts KA/KB, both in principle I and II. When KA or KB breaks, a negative ramp is generated for ports A and B respectively. A contact in break position prevents further signals in the same direction. KA and KB are therefore suitable as limit switches, e.g. for slewing movement on a crane.

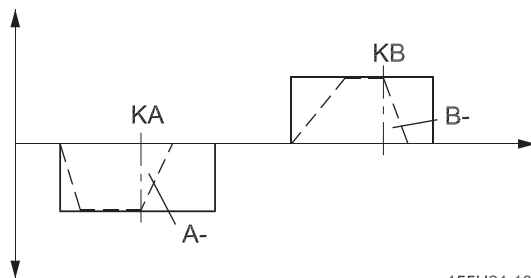

155U21.10

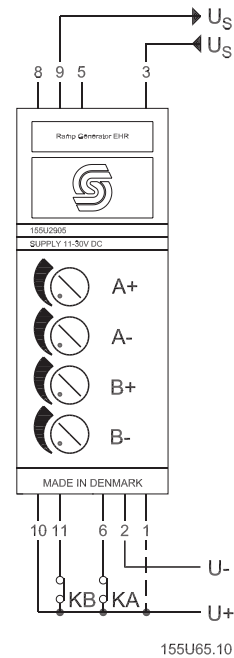

155U65.10

KA, KB Signals

When the voltage on KA/KB is less than 3 V or OFF, the KA/KB function is regarded as OFF and a negative ramp is generated.

When the voltage on KA/KB is greater than 8 V, the KA/KB function is regarded as ON.

In the range between 3 and 8 V, the KA/KB function remains undefined.

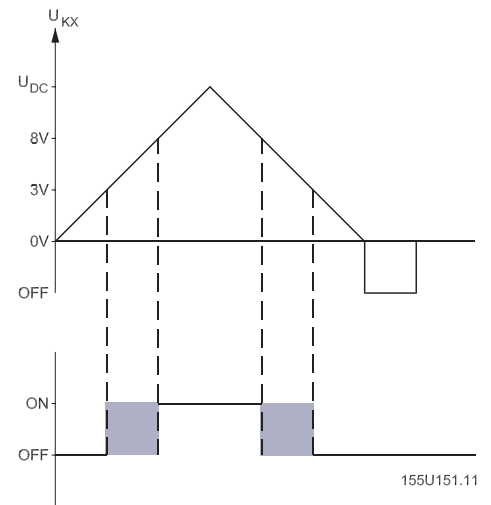

Technical Data

| | | |
|-----------------------------|---|-------------------------------------|
| Supply voltage | U_{DC} | 11 - 30 V |
| | Max. ripple | 5% |
| Current consumption | | < 50 mA |
| Output voltage (U_s) | $\frac{U_s}{U_{DC}}$ | 0.25 → 0.75 |
| Neutral voltage (U_s) | $\frac{U_s}{U_{DC}}$ | 0.5 |
| Input signal | | Remote control lever, potentiometer |
| Input impedance | t_3 | 12 kΩ to $0.5 \cdot U_{DC}$ |
| | $t_{1/6/11}$ | > 5Ω |
| Output signal | max. load | Two parallel connected PVEs |
| | Min. load impedance to $0.5 \cdot U_{DC}$ | M6 kΩ |
| Signal current | $U_{DC} = 12 V$ | ± 0.5 mA |
| | $U_{DC} = 24 V$ | ± 1.0 mA |
| Settings | Positive ramp port A | A+ |
| | Negative ramp port A | A- |
| | Positive ramp port B | B+ |
| | Negative ramp port B | B- |
| External cutoff switches | KA breaks | ramp A - |
| | KB breaks | ramp B - |
| | KA/KB OFF | < 3 V/OFF |
| | KA/KB ON | 8 V → U_{DC} |
| Ramp times (0 to max. flow) | Standard | 0 → 2.5 s. |
| | With external capacitor (C) | 0 → 20 s. |
| Ambient temperature | | -30 to + 60 °C [-22 to 140 °F] |
| Enclosure to IEC 529 | | IP 42 |
| External capacitor (C) | Operating voltage | Min. 10V |
| | Insulation resistance | Min. 5 GΩ |
| | Time constant, RC | Min. 5000 s. |

EHR ramp generator must be connected to supply voltage at the same point as the remote control lever.

**Code Number and
Weight**

| Type | Code number | Weight | |
|------|-------------|--------|------|
| | | kg | [lb] |
| EHR | 155U2905 | 0.12 | 0.26 |

General

The Sauer-Danfoss electronic speed control EHS takes up an electric pulse signal related to rotational movement. e.g. the speed of a shaft, the speed of a vehicle.

The pulse signal is converted into a proportional signal that is applied, via port A on the proportional valve, to control the speed of a hydraulic motor. EHS also gives the possibility of infinite flow regulation.

In other words, EHS and PVG together create a variable electrohydraulic gear.



F301121

Function

EHS controls the flow from the proportional valve, in relation to the frequency of the electric signal from a tachometer pulse source.

EHS contains two potentiometers, used to set the frequency necessary to give maximum movement of the proportional valve and compensate for leakage in the hydraulic system itself.

An externally connected potentiometer allows the infinite regulation of the ratio between frequency and flow.

When a frequency is applied to EHS, the proportional valve immediately functions to give the corresponding flow.

To ensure linearity between frequency and flow, EHS compensates for the progressive flow characteristic of the proportional valve.

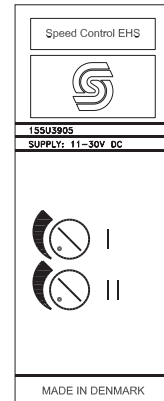

155U161.10

**Potentiometers
 Potentiometer I -
 Adjustment of f_{max}**

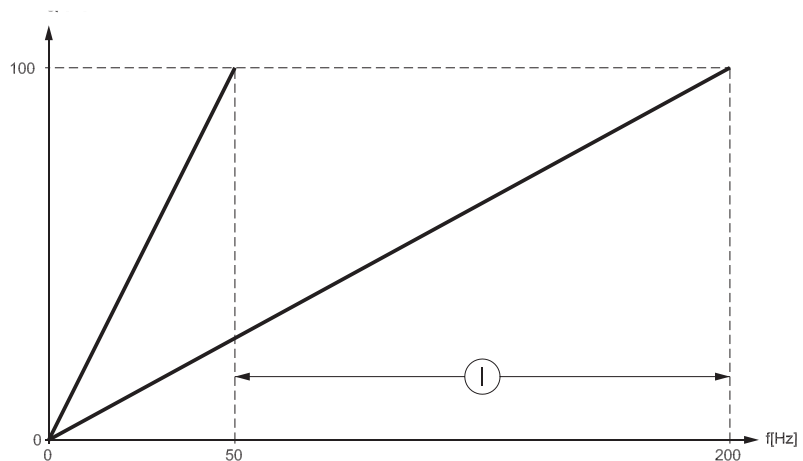

Potentiometer I determines the frequency, f_{max} , i.e. the frequency that must give maximum flow from the proportional valve $50 \text{ Hz} < f_{max} < 200 \text{ Hz}$

Potentiometer II - Adjustment of Q_0

Q_0 is the least flow supplied from the proportional valve. The adjustment of potentiometer II compensates both for the dead band of the proportional valve and leakage in the hydraulic system. Q_0 becomes effective at not more than 3% of f_{max} .

If 100 % (max. flow) is exceeded, potentiometer Px (see section "Potentiometer P") is inserted to eliminate the excess in order to obtain optimum utilisation of the regulation range. If Px is not used, either Q_0 (potentiometer II) or f_{max} (potentiometer I) must be adjusted down.

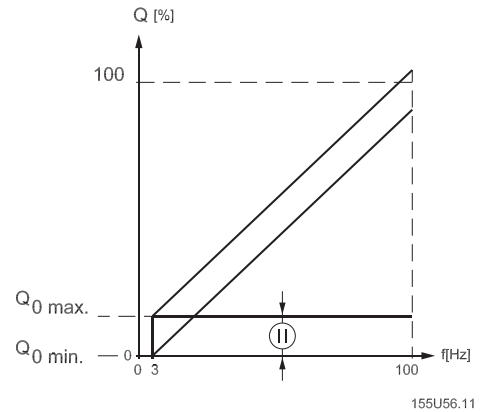

Potentiometer (P)

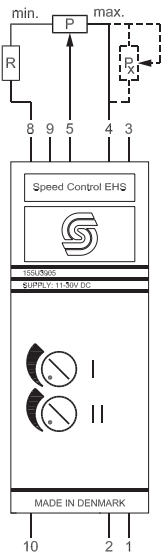

Potentiometer (P) regulates the amplification in EHS and thereby the ratio between frequency and flow.

The resistor (R) increases Q_{min} over Q_0 . R must always be inserted as at least 5% of P.

R can be calculated with f_{max} as:

$$R = \frac{P}{\frac{Q_{max}}{Q_{min}} - 1} [\Omega]$$

$5 \text{ k}\Omega < (R + P (+ Px)) < 22 \text{ k}\Omega$
 R + P : Recommendation 10 k Ω

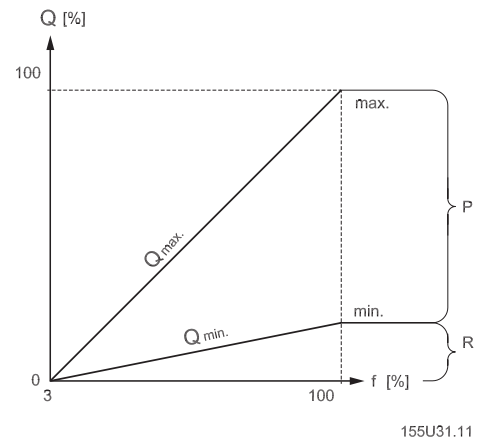

Recommendation

To ensure reliable regulation of the hydraulic system, the ratio between amplitude and pulse pause (X:Y) for the pulse signal must be maintained (see technical data).

It is recommended that EHS be used with electric activation module PVEH in every case.

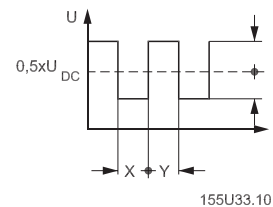

Input Reference

In some cases the pulse source is unable to fulfil the requirement that amplitude must be $\pm 1\text{ V}$ in relation to the reference $0,5 \cdot U_{DC}$.

In these cases it is possible to reduce the reference level by using an external potentiometer between terminals (10) and (2) with input to terminal (1). The reference will then be the same as the voltage level on terminal (1).

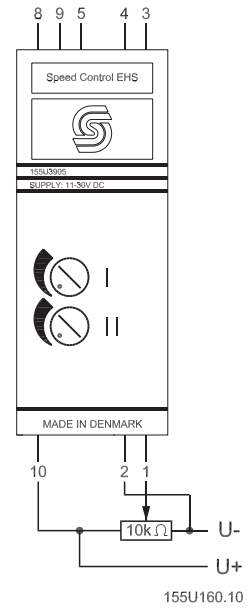

Electrical Connection

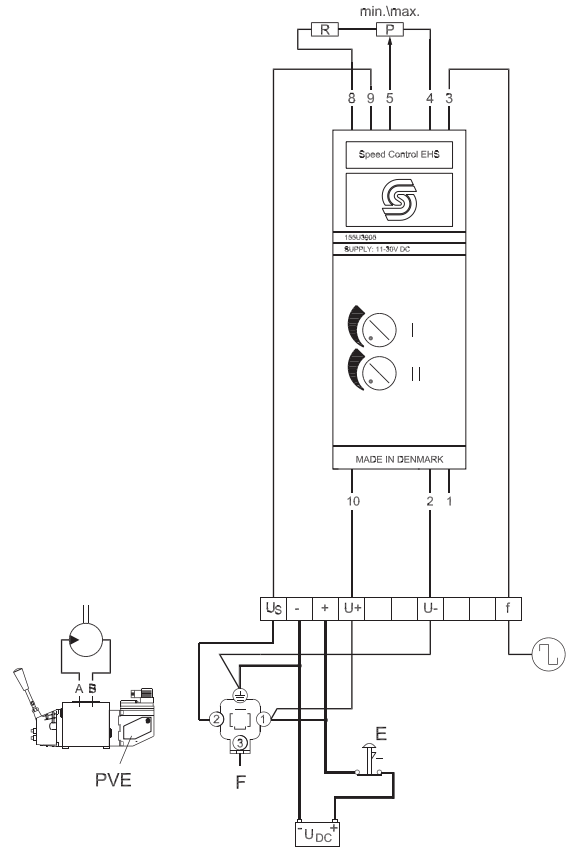
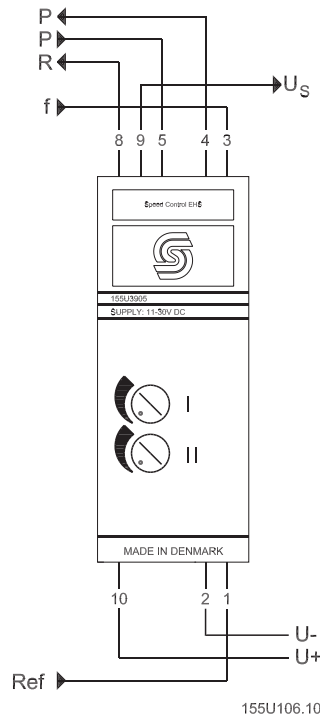

— Signal leads
 — Supply leads

Technical Data

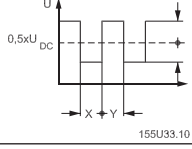
| | | |
|--|---|------------------------------------|
| Supply voltage | U_{DC} | 11 - 30 V |
| | Max. ripple | 5% |
| Current consumption | | < 35 mA |
| Output voltage (U_s) | $\frac{U_s}{U_{DC}}$ | 0.5 → 0.25 |
| Neutral voltage (U_g) | $\frac{U_s}{U_{DC}}$ | 0.5 |
| Input signal  | Pulse source | |
| | Min. amplitude | $0.5 \cdot U_{DC} \pm 1 \text{ V}$ |
| | Pulse - pause ratio (x : y) | 1 : 1 ± 10% |
| | Max. flow frequency | 50 - 200 Hz |
| | Input impedance to $0.5 \cdot U_{DC}$ | 56 Ω |
| Output signal | Max. load | Two parallel connected PVEs |
| | Min. load impedance to $0.5 \cdot U_{DC}$ | 6 kΩ |
| | Flow | P → A |
| | Error in % of U_s max. | < 5 |
| Signal current max. | $U_{DC} = 12 \text{ V}$ | 0 → - 0.5 mA |
| | $U_{DC} = 24 \text{ V}$ | 0 → - 1.0 mA |
| Resistance (terminals (4) to (8)) | R + P (+Px) | 5 → 22 kΩ |
| | Recommended | 10 kΩ |
| Terminal (5) | Impedance to $0.5 \cdot U_{DC}$ | 1 MΩ |
| Terminal (1) | Impedance to $0.5 \cdot U_{DC}$ | > 56 kΩ |
| Ambient temperature | | -30 to + 60 °C [-22 to 140 °F] |
| Enclosure to IEC 529 | | IP 42 |

EHS must be connected to supply voltage at the same point as PVE.

Code Number and Weight

| Type | Code number | Weight | |
|------|-------------|--------|--------|
| | | kg | [lb] |
| EHS | 155U3905 | 0.10 | [0.22] |

General

Sauer-Danfoss electronic, frequency controlled speed control EHSC is used in closed loop control systems. It controls the oil flow from the proportional valve A port and thus the speed of a hydraulic motor.

The speed is adjusted to correspond to a control frequency (speed signal) from, for example, a speed encoder on the wheelaxle of a vehicle. A second speed encoder fitted on the hydraulic motor shaft provides a feedback frequency.

EHSC compares the control and the feedback frequency, and the oil flow is adjusted so the ratio between the two signals is correct. In this way the speed of the hydraulic motor corresponds to the speed of the vehicle. When the vehicle changes speed, the speed of the hydraulic motor will be changed accordingly. This means, for example, that a gritter will distribute a constant quantity of sand over every m^2 road surface - regardless of the speed of the vehicle and the load on the hydraulic motor.



F301124

Adjustment Possibilities

In EHSC there are four built-in potentiometers which are adjusted in order to achieve optimum speed control.

- By adjusting potentiometer I, proportional valve dead band and internal leakage of the hydraulic system are compensated for.
- With potentiometer II the working range of the EHSC is set and thereby the control frequency that gives max. oil flow from the proportional valve.
- With potentiometer III the feedback frequency is set corresponding to maximum motor speed at max. oil flow from the proportional valve.
- With potentiometer IV possible tendencies to system hunting are eliminated.

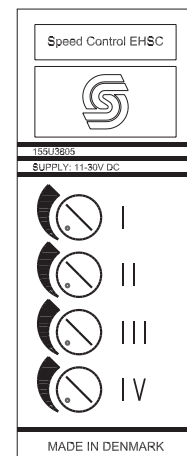

155U130.10

With an external potentiometer the relationship between control frequency and oil flow can be adjusted in the range from 0 to 2. This means that max. oil flow from the proportional valve is possible even at 50% of the set max. control frequency, just as it is possible to shut off oil flow irrespective of control frequency.

Function Monitoring

EHSC has an INFO output controlled by a function monitor. A warning lamp can be connected to the INFO output.

- Constantly lit lamp means that EHSC is functioning correctly.
- Flashing lamp means that the difference between the control and the feedback frequencies is too big for the EHSC to correct.
- Unlit lamp means that either the control or the feedback frequency has been interrupted.

If the feedback frequency has been interrupted, EHSC switches automatically to open loop speed control. This means it will still control the oil flow from the proportional valve, but only in relation to the control frequency.

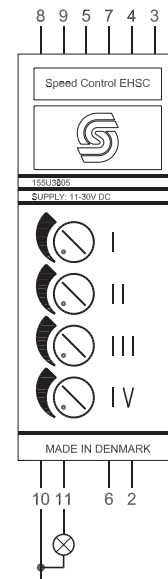

155U132.10

Adjustments

Potentiometer I

Q_0 is the least oil flow supplied from the proportional valve at a stable control frequency (3% of f_{fmax}).

Adjustment of min. oil flow (Q_0)

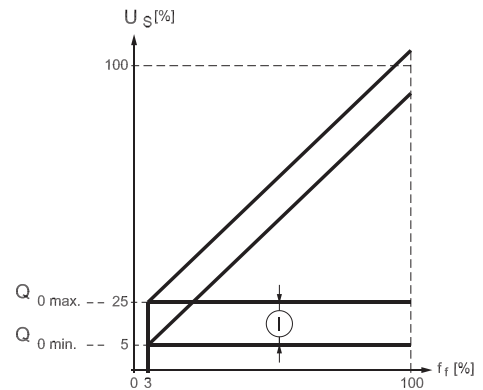

155U127.11

Adjustments (continued) *Potentiometer II*

Adjustment of max. feed back frequency (f_{fmax}): $50 \text{ Hz} < f_{fmax} < 300 \text{ Hz}$.

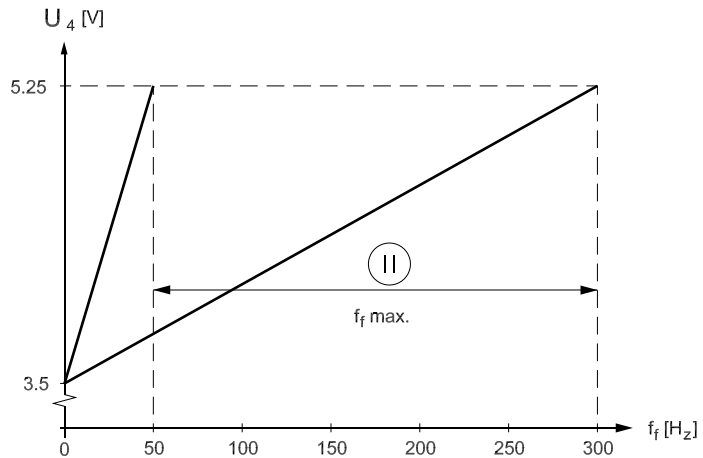

155U83.10

The setting of potentiometer II determines the control frequency giving max. oil flow (Q_{100}) from the proportional valve. If f_{fmax} is set correctly, the test signal terminal 4 (U_4) will be 5,25 V.

If Q_{100} is exceeded, potentiometer Px can be inserted to obtain optimal use of the control range. If Px is not used, either Q_0 or f_{fmax} should be reduced. (See potentiometers I and II).

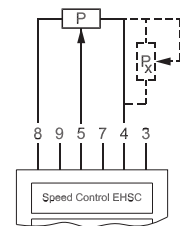

155U137.10

Potentiometer III

Adjustment of max. feed back frequency (f_{bmax})

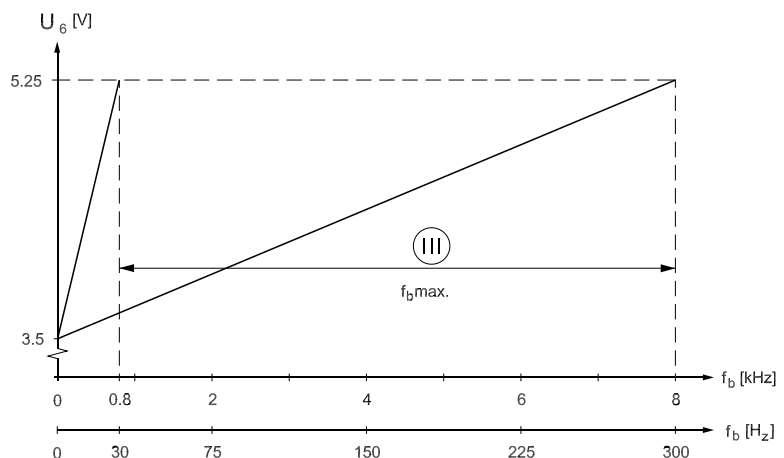

155U85.11

Adjustments (continued)

The setting of potentiometer III determines the max. feedback frequency corresponding to max. speed for the hydraulic motor at max. oil flow.

When ordering EHSC there is a choice of two ranges for feedback frequency:

- 800 Hz < $f_{b \max}$ < 8000 Hz
- or
- 30 Hz < $f_{b \max}$ < 300 Hz.

If $f_{b \max}$ is set correctly, the test signal terminal 6 (U_6), will be 5,25 V.

If the system utilises the maximum flow capacity of the main spool, the test signal on terminal 6 (U_6) must be 5.25 V at $f_{b \max}$.

If the system does not utilise the maximum flow capacity of the main spool, the setting of U_6 must be calculated as follows:

$$U_6 \text{ [V]} = \frac{f_b \text{ [Hz]}}{f_{b \max} \text{ [Hz]}} \cdot 1,75 \text{ [V]} + 3,5 \text{ [V]}$$

f_b is the actual maximum system feedback frequency. $f_{b \max}$ is the feedback frequency on maximum movement of the main spool.

Both f_b and $f_{b \max}$ can be calculated thus:

$$f_b \text{ [Hz]} = \frac{\frac{Q \text{ l/min [US gal/min]}}{\text{motor displacement [cm}^3]} \cdot \text{ppr} \cdot 1000}{60}$$

In calculating f_b , Q is inserted as the actual max. system flow. At $f_{b \max}$, Q is inserted as the maximum flow capacity of the main spool.

Example:

| Main spool | Motor |
|---------------------------------|--------------------|
| PVG 32 | OMS 80 EM |
| 157B9764 | 151F3000 |
| 100 l/min [26.42 US gal/min] | 80 cm ³ |
| (4/3-open) | (ppr = 15) |

$$f_b \text{ [Hz]} = \frac{\frac{65 \text{ l/min [17.17 US gal/min]}}{80 \text{ cm}^3} \cdot 15 \cdot 1000}{60} = 203 \text{ Hz}$$

$$f_{b \max} \text{ [Hz]} = \frac{\frac{100 \text{ l/min [26.42 US gal/min]}}{80 \text{ cm}^3} \cdot 15 \cdot 1000}{60} = 313 \text{ Hz}$$

$$U_6 \text{ [V]} = \frac{203 \text{ Hz}}{313 \text{ Hz}} \cdot 1.75 \text{ [V]} + 3.5 \text{ [V]}$$

**Adjustments
 (continued)**

Potentiometer IV

Potentiometer IV is used to set the integration time in the EHSC integrator stage. The integrator stage equalises the difference between forward and feedback frequencies. The integration time can be set between 50 and 300 ms.

A short integration time means fast correction of speed deviations.

The permissible integration time is systemdependent. Too short an integration time can produce hunting in the system.

Potentiometer (P)

The external potentiometer (P) determines the relationship between the control frequency and the oil flow. The ratio is infinitely variable in the range from 0 to 2.

Max. oil flow is achieved from
 $0.5 \leftrightarrow f_{f \max}$ at $P = 2$.

The oil flow may be cut off in the entire control range at $P = 0$.

Recommended value for potentiometer resistance P: 10 k Ω

Range for potentiometer resistance
 P: 5 k Ω < P < 20 k Ω

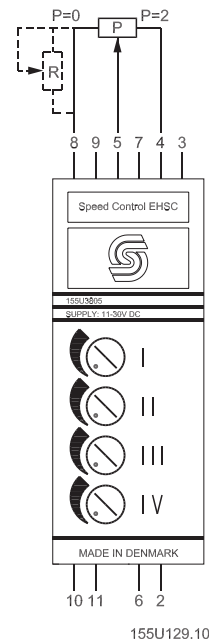

Resistance (R)

$$R = \frac{P [\Omega]}{\frac{Q_{\max}}{Q_{\min}} - 1} [\Omega]$$

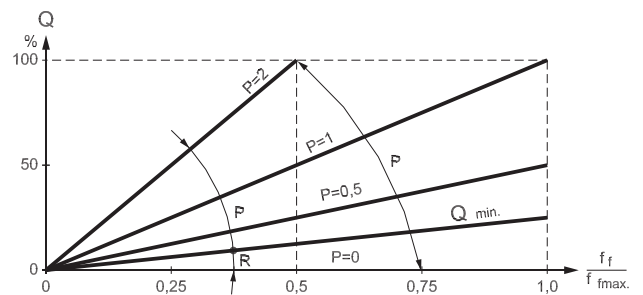

The resistance (R) is only inserted if the oil flow must not be cut off completely. R forms a lower limit for the control frequency and oil flow (Q_{\min}) ratio.

Recommended value for the total resistance $P + R = 10 \text{ k}\Omega$

Range for the total resistance $P + R$: 5 k Ω < $P + R$ < 20 k Ω

Electrical System

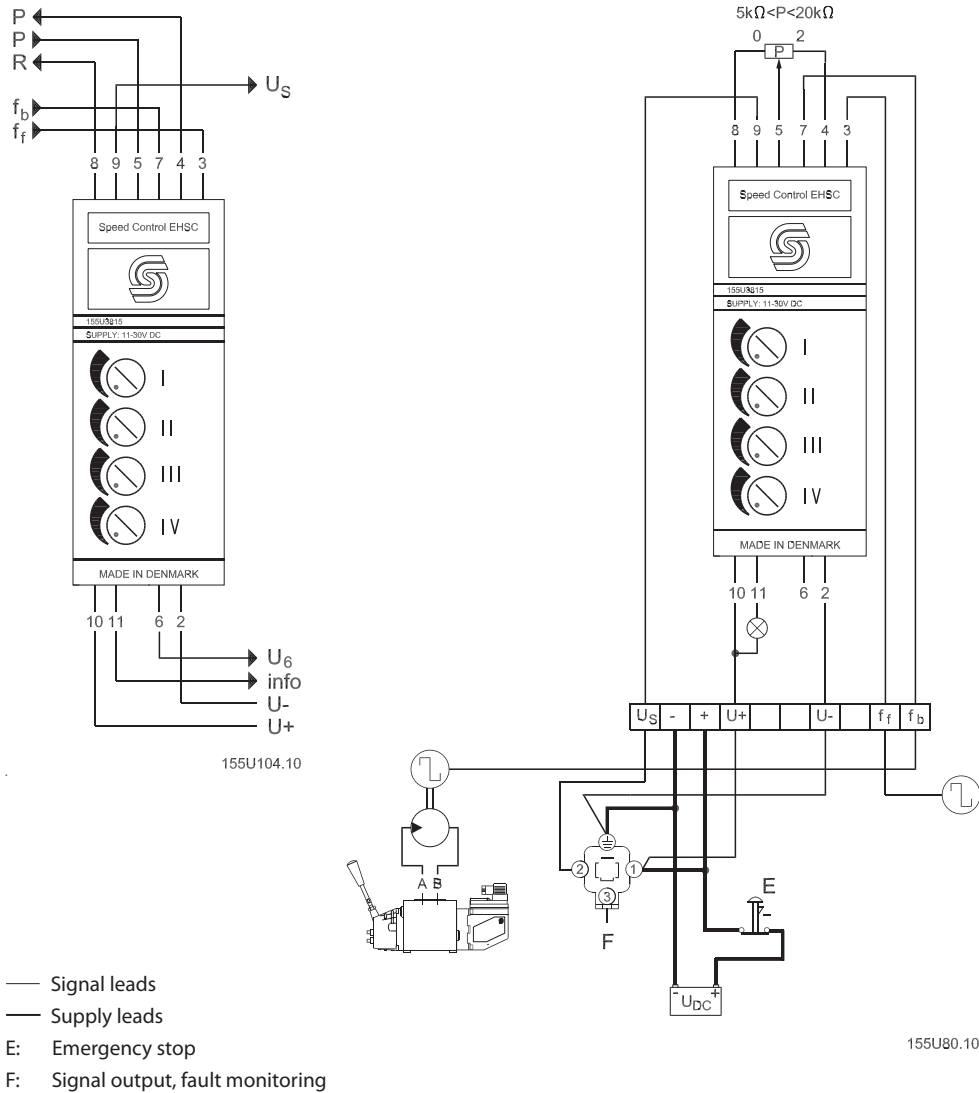

Electrical System

| | | |
|--|---|--|
| Supply voltage ¹⁾ | U_{DC} | 11 - 30 V |
| | Max. ripple | 5% |
| Current consumption | | < 100 mA |
| Control frequency ²⁾ | Min. amplitude | 3.5 V \pm 1 V |
| | Pulse-pause-ratio | 1 : 1 \pm 10% |
| | Frequency at max.flow | 50 - 300 HZ |
| | Input impedance | >30 k Ω |
| Control frequency test, value at max. control frequency (terminal 4) | | 5.25 V |
| Signal voltage (U_s) | | 0.50 \rightarrow 0.25 \cdot U_{DC} |
| Neutral position voltage ($f_r = 0$ Hz) | | 0.50 \cdot U_{DC} |
| Feedback frequency ²⁾ | Min. amplitude | 3.5 V \pm 1 V |
| | Pulse-pause-ratio | 1 : 1 \pm 10% |
| | Frequency at max.flow | 800 \rightarrow 8000 Hz 30 \rightarrow 300 Hz |
| | Input impedance | > 30 k Ω |
| Feedback frequency test, value at max. frequency (terminal 6) | | 5.25 V |
| Output signal | Max. load | Two parallel connected PVE |
| | Min. load impedance to 0.5 \cdot U_{DC} | 6 k Ω |
| | Error in relation to max. flow | < 1% |
| Oil flow direction | $U_s = 0.50 \rightarrow 0.75 \cdot U_{DC}$ | P \rightarrow A |
| | $U_s = 0.50 \rightarrow 0.25 \cdot U_{DC}$ | P \rightarrow B |
| Signal current | $U_{DC} = 12$ V | 0 \rightarrow -0.5 mA |
| | $U_{DC} = 24$ V | 0 \rightarrow -1.0 mA |
| Load between terminals 4 and 8 | P or (P + R) | 5 \rightarrow 20 k Ω |
| | Recommended | 10 k Ω |
| Input impedance (terminal 5) | | > 1 M Ω |
| Info output (terminal 11) | Max. load | -100 mA |
| Ambient temperature | | - 30 \rightarrow + 60°C [-22 to 140 °F] |
| Enclosure to IEC 529 | | IP 42 |

¹⁾ EHSC must be connected to the voltage supply in the same place as PVE.
²⁾ See required control and feedback frequency signal below.

Required Control and Feedback Frequency Signal

To ensure reliable control of the hydraulic system, it is necessary to comply with the amplitude and pulse/pause ratio (X : Y) stated for the control and feedback frequencies (see technical data).

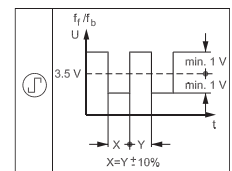

155U78.10

Main Spools and Electrical Actuation Modules

Sauer-Danfoss recommends the use of a PVBS main spool with linear characteristic and a PVES electrical actuation module.

Code Number and Weight

| Type | EHSC |
|--------------------|-------------------------|
| Code number | 155U3815 |
| Weight kg [lb] | 0.14 [0.31] |
| Feedback frequency | 30 \rightarrow 300 Hz |

General

Danfoss electronic, voltage controlled speed control EHSC is used in closed loop control systems. It controls the oil flow from the A and B ports of the proportional valve and consequently the speed of a hydraulic motor. The speed is controlled so that it corresponds to an analogue voltage signal from e.g. a remote control lever. A speed encoder connected to the hydraulic motor shaft provides a feedback frequency.

EHSC compares the control signal with the feedback frequency and controls, via a PVG proportional valve, the oil flow so that the feedback frequency corresponds to the control signal. The speed of the hydraulic motor will then correspond to the movement of the remote control lever regardless of the load on the hydraulic motor.



F301125

Adjustment Possibilities

In the EHSC four built-in potentiometers are used for the adjustment, to achieve optimum speed control:

- Adjusting potentiometers I and II compensates for proportional valve dead band in directions A and B plus the internal leakage of the hydraulic system.
- Potentiometer III sets the max. feedback frequency corresponding to the max. speed of the motor at max. oil flow from the proportional valve.
- With potentiometer IV possible tendencies of system hunting are eliminated.

With an external potentiometer the relationship between control signal and oil flow can be infinitely varied in the 0 to 1 range. A reduction of the control signal and oil flow ratio applies to both the A and the B port.

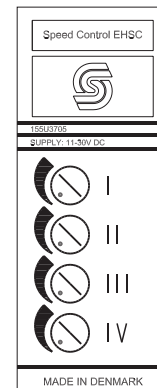

155U136.10

Function Monitoring

EHSC has an INFO-output controlled by a function monitor. A warning lamp can be connected to the INFO output.

- Constantly lit lamp means that EHSC is functioning correctly
- Flashing lamp means that the deviation between the control signal and feedback frequency is too big for EHSC to correct.
- No light means that the control signal or the feedback frequency has been cut off.

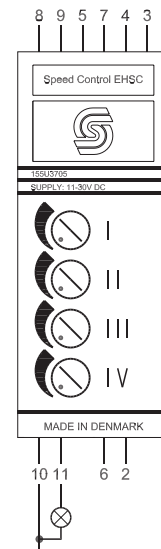

155U135.10

The INFO-output cannot be damaged by a short circuit.

If the feedback frequency is cut off, EHSC switches automatically to open loop speed control. This means that EHSC is still controlling the oil flow from the proportional valve, but now only in relation to the control signal.

The control signal is constantly monitored. If the signal is outside the range $0.15 \rightarrow 0.85 \cdot U_{DC}$, the signal output to PVE is cut off. This results in the main spool returning to neutral position, and at the same time the INFO-output light will switch off.

If the function monitor has cut off the signal output, EHSC can only be re-activated after a disconnection of the supply voltage.

Adjustments

Potentiometer I
Potentiometer II

Adjustment of min. oil flow (Q_{0A}), A-port
Adjustment of min. oil flow (Q_{0B}), B-port

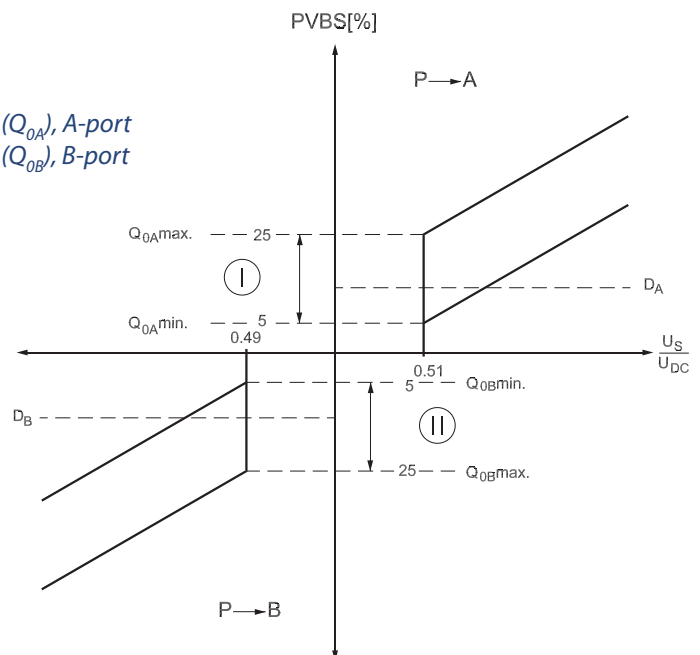

D_A : Dead band P \rightarrow A
 D_B : Dead band P \rightarrow B

155U94.11

Q_0 is the smallest oil flow supplied by the proportional valve at a stable control signal.

**Adjustments
(continued)**

Potentiometer III

Adjustment of max. feedback frequency ($f_{b \max}$)

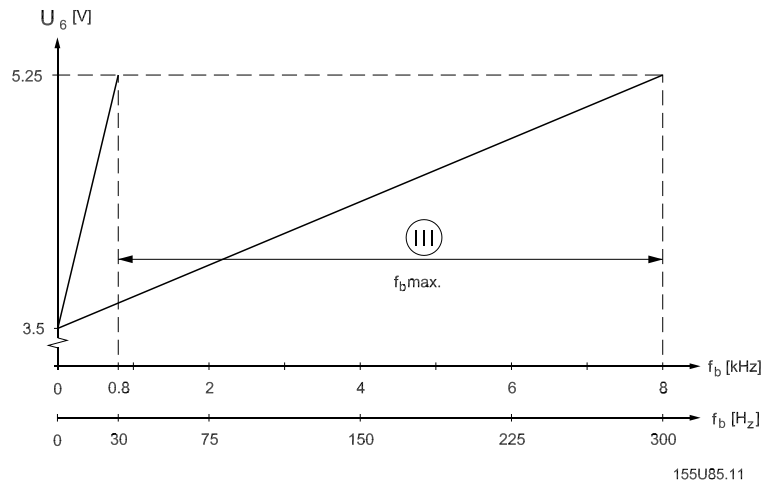

The setting of potentiometer III determines the max. feedback frequency corresponding to max. speed for the hydraulic motor at max. oil flow.

When ordering EHSC there is a choice of two ranges for feedback frequency:

- $800 \text{ Hz} < f_{b \max} < 8000 \text{ Hz}$
- or
- $30 \text{ Hz} < f_{b \max} < 300 \text{ Hz}$.

If the $f_{b \max}$ setting is correct, the test signal terminal 6 (U_6), will be 5.25 V.

If the system utilises the maximum flow capacity of the main spool, the test signal on terminal 6 (U_6) must be 5.25 V at $f_{b \max}$.

If the system does not utilise the maximum flow capacity of the main spool, the setting of U_6 must be calculated as follows:

$$U_6 \text{ [V]} = \frac{f_b \text{ [Hz]}}{f_{b \max} \text{ [Hz]}} \cdot 1.75 \text{ [V]} + 3.5 \text{ [V]}$$

f_b is the actual maximum system feedback frequency. $f_{b \max}$ is the feedback frequency on maximum movement of the main spool.

Both f_b and $f_{b \max}$ can be calculated thus:

$$f_b \text{ [Hz]} = \frac{\frac{Q \text{ l/min [US gal/min]}}{\text{motor displacement [cm}^3]} \cdot \text{ppr} \cdot 1000}{60}$$

In calculating f_b , Q is inserted as the actual max. system flow. At $f_{b \max}$, Q is inserted as the maximum flow capacity of the main spool.

**Adjustments
 (continued)**

Example:

| Main spool | Motor |
|---------------------------------|--------------------|
| PVG 32 | OMS 80 EM |
| 157B9764 | 151F3000 |
| 100 l/min [26.42 US gal/min] | 80 cm ³ |
| (4/3-open) | (ppr = 15) |

$$f_b \text{ [Hz]} = \frac{65 \text{ l/min [17.17 US gal/min]} \cdot 15 \cdot 1000}{80 \text{ cm}^3 \cdot 60} = 203 \text{ Hz}$$

$$f_{b \text{ max}} \text{ [Hz]} = \frac{100 \text{ l/min [26.42 US gal/min]} \cdot 15 \cdot 1000}{80 \text{ [cm}^3\text{]} \cdot 60} = 313 \text{ Hz}$$

$$U_6 \text{ [V]} = \frac{203 \text{ Hz}}{313 \text{ Hz}} \cdot 1.75 \text{ [V]} + 3.5 \text{ [V]}$$

Potentiometer IV - Error signal amplification

Potentiometer IV - Error signal amplification

Potentiometer IV is used to set the amplification of the deviation between the control signal and the feedback frequency. This amplification means that even small deviations can be corrected.

The permissible amplification factor depends on the system. An excessively high factor may lead to system hunting.

Potentiometer (P)

The external potentiometer (P) determines the relationship between the control signal and the oil flow. The ratio is infinitely variable from 0 to 1. The oil flow can be cut off completely within the control range (at P = 0).

Recommended value for potentiometer resistance P: 10 kΩ

Range for potentiometer resistance:
 P: 5 kΩ < P < 20 kΩ



155U134.11

Resistance (R)

The resistance (R) is only inserted if the oil flow must not be cut off.
R marks a lower limit for the control signal and oil flow (Q_{min}) ratio.

$$R = \frac{P [\Omega]}{Q_{max}} \cdot \frac{Q_{min}}{1} [\Omega]$$

Recommended value for the total resistance $P + R = 10 \text{ k}\Omega$
Range for the total resistance $P + R: 5 \text{ k}\Omega < P + R < 20 \text{ k}\Omega$

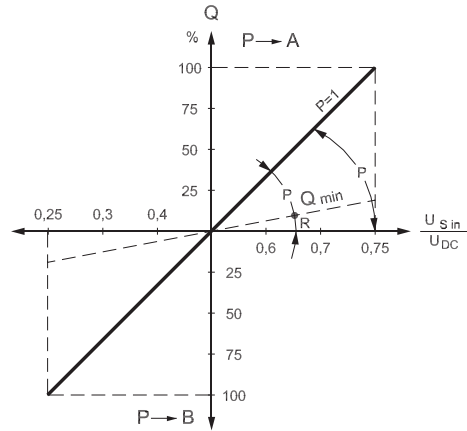

155U133.10

Electrical System

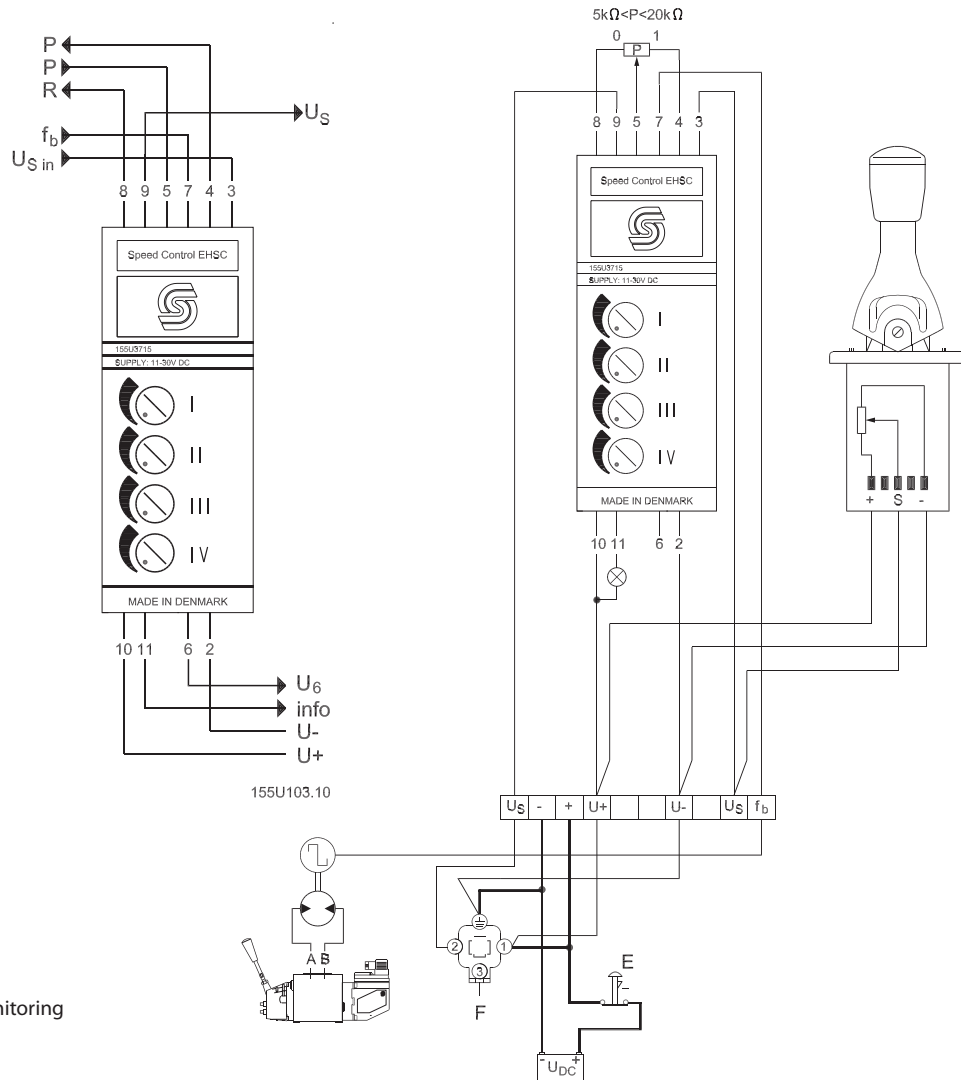

- Signal leads
- Supply leads
- E : Emergency stop
- F : Signal output, fault monitoring

Technical Data

| | | | |
|---|--|---|---------------------------|
| Supply voltage ¹⁾ | U_{DC} | 11 - 30 V | |
| | Max. ripple | 5% | |
| Current consumption | | < 100 mA | |
| Signal voltage (U_s) | | $0.50 \rightarrow 0.75 \cdot U_{DC}$ | |
| Neutral position signal | | $0.5 \cdot U_{DC}$ | |
| Control signal | | Remote control lever or potentiometer | |
| | Input impedance | > 30 k Ω | |
| Feedback frequency ²⁾ | Min. amplitude | $3.5 \text{ V} \pm 1 \text{ V}$ | |
| | Pulse-pause-ratio | 1 : 1 \pm 10% | |
| | Frequency at max. flow | | 800 \rightarrow 8000 Hz |
| | | | 30 \rightarrow 300 Hz |
| | Input impedance | > 30 k Ω | |
| Feedback frequency test, value at max. frequency (terminal 6) | | 5.25 V | |
| Output signal | Max. load | Two parallel connected PVEs | |
| | Min. load impedance to $0.5 \cdot U_{DC}$ | 6 k Ω | |
| | Error in relation to max. flow | < 1% | |
| Oil flow direction | $U_s = 0.50 \rightarrow 0.75 \cdot U_{DC}$ | P \rightarrow A | |
| | $U_s = 0.50 \rightarrow 0.25 \cdot U_{DC}$ | P \rightarrow B | |
| Signal current | $U_{DC} = 12 \text{ V}$ | $\pm 0.5 \text{ mA}$ | |
| | $U_{DC} = 24 \text{ V}$ | $\pm 1.0 \text{ mA}$ | |
| Load between terminals 4 and 8 | P or (P + R) | 5 \rightarrow 20 k Ω | |
| | Recommended | 10 k Ω | |
| Input impedance (terminal 5) | | > 1 M Ω | |
| Info output (terminal 11) | Max. load | -100 mA | |
| Ambient temperature | | -30 \rightarrow +60°C [-22 to 140 °F] | |
| Enclosure to IEC 529 | | IP 42 | |

¹⁾ EHSC must be connected to the voltage supply in the same place as PVE.

²⁾ See required control and feedback frequency signal below.

Required Feedback Frequency Signal

To ensure reliable control of the hydraulic system it is necessary to comply with the amplitude and pulse/pause ratio for the feedback frequency (see technical data).

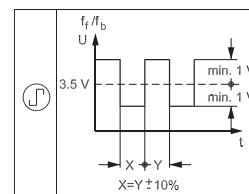

155U78.10

Main Spools and Electrical Actuation Modules

Sauer-Danfoss recommends the use of a PVBS main spool with linear characteristic and a PVES electrical actuation module.

Code Number and Weight

| Type | EHSC |
|--------------------|-------------------------|
| Code number | 155U3715 |
| Weight kg [lb] | 0.14 [0.31] |
| Feedback frequency | 30 \rightarrow 300 Hz |

General

Sauer-Danfoss electronic position control EHC is used for the positioning of an actuator in a closed loop control system. The set-point signal is an analogue voltage signal from e.g. a remote control lever. A position transducer on the actuator provides the feedback signal (position signal).

EHC compares the set-point signal with the feedback signal and adjusts the oil flow, via the PVG proportional valve, so that the actuator position corresponds to the set-point signal.

This means that the actuator shaft or piston rod is moved into and kept in the position corresponding to the controlling movement of the remote control lever.



F301125

Adjustment Possibilities

In EHC there are four built-in potentiometers for the adjustment of EHC, in order to achieve optimum position control.

- Potentiometer I - Setting of scale for set point signal.
- Potentiometer II - Setting of scale for feedback signal.

The scale settings for the set-point and feedback signals are used for the adjustment of standard transducers, so their signal range can be fully utilized.

The scaling is used when, e.g. a 270° angle transducer is utilized only in 60° of its turning range.

Potentiometers I and II can be set for between 1 and 4 times amplification of the set-point and feedback signals respectively. The amplification is made in proportion to half supply voltage ($0,5 \cdot U_{DC}$).

- Potentiometer III - Position adjustment. The position adjustment adds a fixed signal to the set-point signal. The adjustment is used to make sure that the set-point signal and feedback signal correspond to each other at a certain, critical actuator position. This may be the neutral position, an extreme position, etc.
- Potentiometer IV - Error signal amplification control. Potentiometer IV is used to set the amplification of the deviations between the set-point signal and the feedback signal. The amplification means that even small deviations can be corrected. The amplification factor can be set at between 1 and 100.

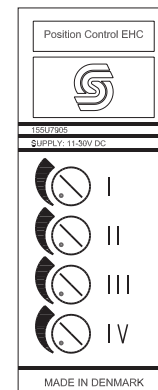

155U113.10

Inverse Function

With the built-in inverse function the EHC set-point signal can be reversed in relation to $0,5 \cdot U_{DC}$ so that

- set-point signals in the $0,5 \rightarrow 0,75 \cdot U_{DC}$ range are converted to set-point signals in the $0,5 \rightarrow 0,25 \cdot U_{DC}$ range and
- set-point signals in the $0,5 \rightarrow 0,25 \cdot U_{DC}$ range are converted to set-point signals in the $0,5 \rightarrow 0,75 \cdot U_{DC}$ range.

The inverse function is activated by connecting terminals 1 and 10. If terminals 1 and 10 are connected via a switch, it will be possible to alternate between normal and inverse function.

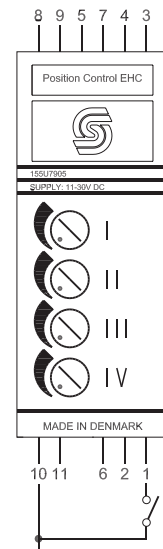

155U114.10

Interruption of the Signal Output

The signal output to the proportional valve (U_s) can be controlled by placing a make contact between terminals 6 and 10. If this connection between terminals 6 and 10 is made, the signal to the proportional valve and the INFO-output are interrupted.

When there is no connection between terminals 6 and 10, the signal output is controlled by the function monitoring alone.

The external contact function cannot be used on EHC with no relay in the signal output.

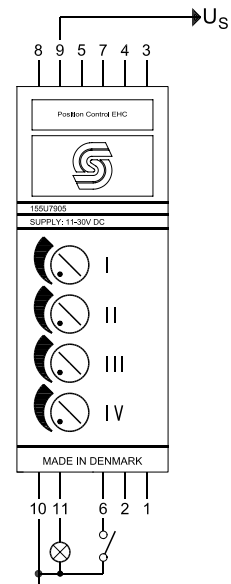

155U111.10

ON/OFF Signal t_1/t_6

When voltage on t_1/t_6 is less than 3 V or OFF, the t_1/t_6 function is regarded as OFF.

When t_1/t_6 voltage is greater than 8 V, the t_1/t_6 function is regarded as ON.

In the range 3 to 8 V, t_1/t_6 remains undefined.

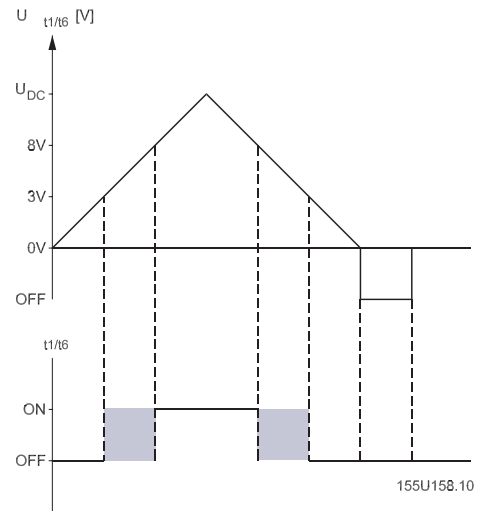

Redundant Position Transducer

EHC can receive and compare two parallel feedback signals. This gives higher system security.

In case just one of the signals fails, the INFO-output is switched off (and the signal output, terminal 9, if any). See the section on function monitoring. If only one position transducer is used, it must be connected to both terminals 5 and 7.

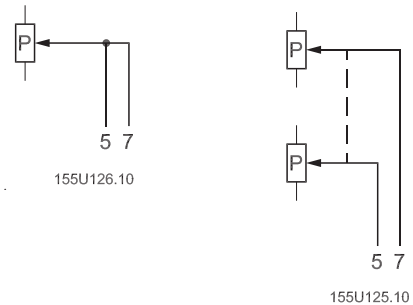

Function Monitoring

EHC has function monitoring on the set-point and feedback signals. The function monitoring has two purposes:

- 1) Via a relay in the signal output terminal 9 to cut off the signal to the proportional valve in case of a functional error.
- 2) Via the INFO-output (terminal 11) to indicate an error, for example via a connected lamp.

$$0.5 \cdot U_{DC} \pm \frac{0.35 \cdot U_{DC}}{\text{scale value for pot. I or pot. II}}$$

EHC is available in a version without a relay in the signal output.

- that the two feedback signals must be the same.

If the limits are exceeded, the relay in the signal output will be cut off, and the INFO-output will be switched off.

If the function monitoring has cut off the relay and the INFO-output, EHC can only be reactivated after a disconnection of the supply voltage.

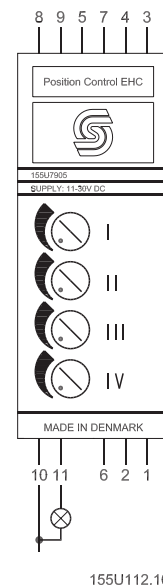

Adjustment

Potentiometer I

- Setting of set-point signal scale (factor 1 to 4)

Potentiometer II

- Setting of feedback signal scale (factor 1 to 4)

The set scale for the set-point signal can be checked by measuring the resulting voltage on **terminal 4**.

The set scale for the feedback signal can be checked by measuring the resulting voltage on **terminal 8**.

The scale for the feedback signal applies to both feedback signals (**terminals 5 and 7**).

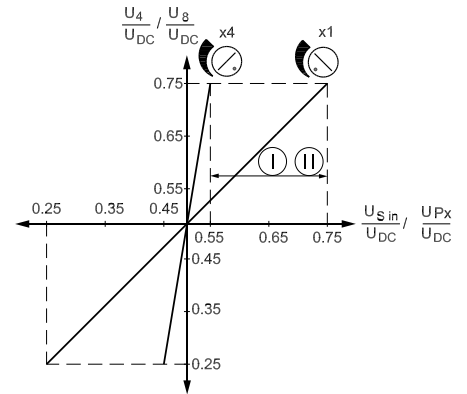

155U122.10

Potentiometer III - Position adjustment

The position adjustment makes a controlled offset of the actuator possible.

The offset is obtained by adding a voltage of up to $\pm 0,05 \leftrightarrow U_{DC}$ to the set-point signal.

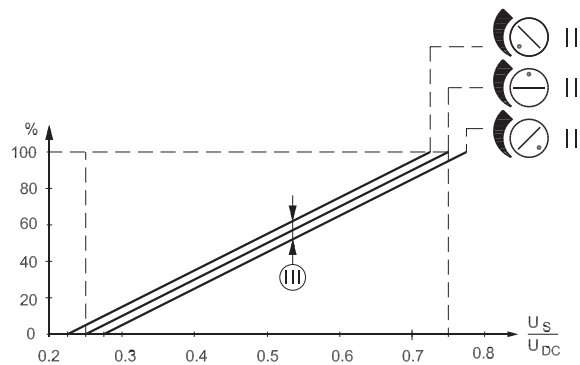

155U124.11

a: Relative actuator movement

Potentiometer IV - Error signal amplification

Potentiometer IV is used to set the amplification of the error signal. The amplification factor can be set at between 1 and 100. The amplification factor determines the response time of the system.

A high amplification factor gives quick response. The permissible amplification factor is depending on the system. A too high amplification factor leads to hunting.

Electrical System

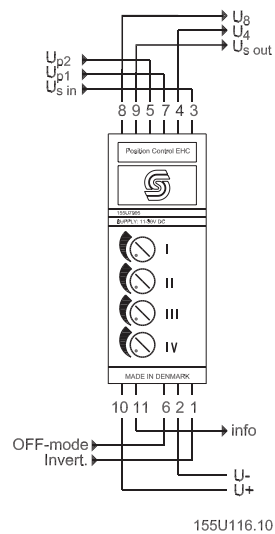

155U116.10

- Signal leads
- Supply leads
- E: Emergency stop
- F: Signal output, fault monitoring
- P: The effective working range of the position transducer
- R: Series resistances (may be part of the total working area of the position transducer)

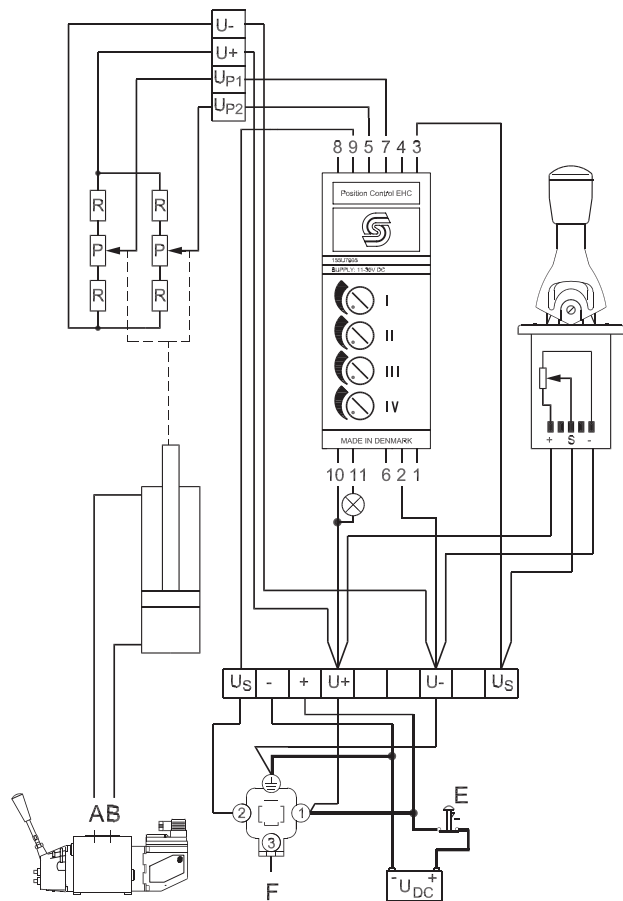

155U117.12

Resistance values:

Control signal

- $0,125 \leftrightarrow (R+P+R) < P < 0,5 \leftrightarrow (R+P+R)$
- $1 \text{ k}\Omega < (R+P+R) < 10 \text{ k}\Omega$
- $(R+P+R)$ recommended $3 \text{ k}\Omega$

Position signal

- $1 \text{ k}\Omega < (R+P+R) < 100 \text{ k}\Omega$
- $(R+P+R)$ recommended $10 \text{ k}\Omega$

These resistance demands also apply to the set-point signal source.

When Sauer-Danfoss remote control levers are used as set-point signal source, these demands are always complied with.

Electrical System

| | | |
|---|---|--|
| Supply voltage ¹⁾ | U_{DC} | 11 - 30 V |
| | Max. ripple | 5% |
| Current consumption | | < 100 mA |
| Signal voltage (U_s) | | $0.50 \rightarrow 0.75 \cdot U_{DC}$ |
| Neutral position signal (U_z) | | $0.5 \cdot U_{DC}$ |
| Control signal | Signal transmitter | Remote control lever or potentiometer |
| | Input impedance | >30 k Ω |
| Feedback | Signal transmitter | Potentiometer ohmic transducer or the like |
| | Input impedance | >1 M Ω |
| Amplification factor for control signal in relation to $0.5 \cdot U_{DC}$ | Pot. I | 1 \rightarrow 4 |
| Amplification factor for control signal in relation to $0.5 \cdot U_{DC}$ | Pot. II | 1 \rightarrow 4 |
| Position adjustment | Pot. III | $\pm 0.05 \cdot U_{DC}$ |
| Amplification factor | Pot. IV | 1 \rightarrow 100 |
| Control signal test at max. control signal (terminal 4) | | $0.25/0.75 \cdot U_{DC}$ |
| Feedback signal test at max. control signal (terminal 8) | | $0.25/0.75 \cdot U_{DC}$ |
| Output signal | Max. load | Two parallel connected PVEs |
| | Min. load impedance to $0.5 \cdot U_{DC}$ | 6 k Ω |
| Signal current | $U_{DC} = 12 V$ | $\pm 0.5 mA$ |
| | $U_{DC} = 24 V$ | $\pm 1.0 mA$ |
| Info output (terminal 11) | Max. load | - 100 mA |
| Input impedance t_1/t_6 | | > 1 M Ω |
| Ambient temperature | | - 30 \rightarrow + 60°C [-22 to 140°F] |
| Enclosure to IEC 529 | | IP 42 |

EHC must be connected to the voltage supply in the same place as PVE.

Code Numbers and Weight

| Type | EHC | EHC |
|----------------|-------------------------------|-------------------------------|
| Code number | 155U7905 | 155U7915 |
| Weight kg [lb] | 0.14 [0.31] | 0.14 [0.31] |
| Specifications | With a relay in signal output | Without a relay signal output |

Dimensions

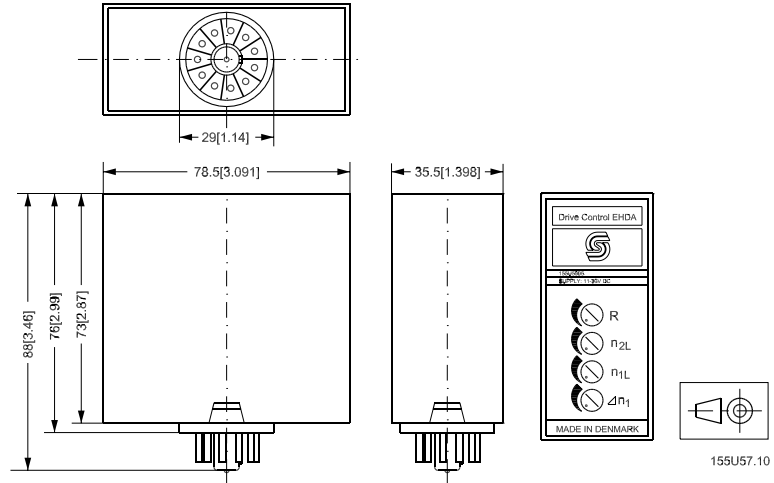



Electronic Control Modules - EH Modules
Technical Information
Notes

Notes



Electronic Control Modules - EH Modules
Technical Information
Notes

Notes



Electronic Control Modules - EH Modules
Technical Information
Notes

Notes



Our Products

Open circuit axial piston pumps
Gear pumps and motors
Fan drive systems
Closed circuit axial piston pumps and motors
Bent axis motors
Hydrostatic transmissions
Transit mixer drives
Hydrostatic transaxles
Electrohydraulics
Integrated systems
Microcontrollers and software
PLUS+1™ GUIDE
Displays
Joysticks and control handles
Sensors
Orbital motors
Inverters
Electrohydraulic power steering
Hydraulic power steering
Hydraulic integrated circuits (HIC)
Cartridge valves
Directional spool valves
Proportional valves

Sauer-Danfoss Mobile Power and Control Systems – Market Leaders Worldwide

Sauer-Danfoss is a comprehensive supplier providing complete systems to the global mobile market.

Sauer-Danfoss serves markets such as agriculture, construction, road building, material handling, municipal, forestry, turf care, and many others.

We offer our customers optimum solutions for their needs and develop new products and systems in close cooperation and partnership with them.

Sauer-Danfoss specializes in integrating a full range of system components to provide vehicle designers with the most advanced total system design.

Sauer-Danfoss provides comprehensive worldwide service for its products through an extensive network of Global Service Partners strategically located in all parts of the world.

Local address:

Sauer-Danfoss (US) Company
2800 East 13th Street
Ames, IA 50010, USA
Phone: +1 515 239-6000
Fax: +1 515 239 6618

Sauer-Danfoss ApS
DK-6430 Nordborg, Denmark
Phone: +45 7488 4444
Fax: +45 7488 4400

Sauer-Danfoss GmbH & Co. OHG
Postfach 2460, D-24531 Neumünster
Krokamp 35, D-24539 Neumünster, Germany
Phone: +49 4321 871-0
Fax: +49 4321 871 122

Sauer-Danfoss-Daikin LTD.
Shin-Osaka TERASAKI 3rd Bldg. 6F
1-5-28 Nishimiyahara, Yodogawa-ku
Osaka 532-0004, Japan
Phone: +81 6 6395 6066
Fax: +81 6 6395 8585